

SHAKING WATER BATH



Instruction Manual



Model : LSWB-30T

Please read this manual carefully before using the instrument

Labnics Equipment

Table of Content

CHAPTER	CONTENT	PAGE NO.
1.	Before Use	1
2.	Safety Precaution	1
2.1	Power Connection	1
2.2	Installation	2
2.3	Operation	2
2.4	Maintenance	2
3.	Product Feature	3
4.	Specifications	4
5.	Parts and Functions	4
6.	Operation	8
7.	Frequently Asked Questions	12
8.	Trouble Shooting	13
9.	Setting Factory Parameters	13
10.	Inspection Log	17
11.	Service Report	18

CHAPTER1. BEFORE USE:-

- Thank you for choosing **Labnics** Equipment Laboratory Products .
- Please read this Operation manual carefully before use for your safety and optimum operating performance.
- If you have any question, please contact sales representative or service engineer.

CHAPTER 2. SAFETY PRECAUTION:-

This manual contains important operating and safety information. You must carefully read and understand the contents of this manual prior to the use of this equipment.



Warning:-

Warning alert you to a possibility of personal injury



Caution:-

Caution alerts you to a possibility of damage to the equipment.

2.1 Power Connection:-



Caution

1. Your Digital Water Bath is designed for 110VAC/60 Hz 1P or 220VAC 50/60 Hz 1P.
2. Check electrical requirement on the name plate before use.
3. Connect to receptacle with ground connection.
4. Make sure to connect on sufficient electrical current receptacle.

2.2 Installation:-



Caution

1. Do not use in high humid environment.
 - May cause Electrical leakage
 - Corrosion may occur
2. Do not use in high temperature environment.
3. Do not use beside instrument generate heat.
4. Place flat, rigid and leveled surface.

2.3 Operation :



Warning

1. Hot surface may cause serious injury.
2. Hot liquid in the bath may cause serious injury.
3. Do not put volatile, flammable and explosive material inside of bath.
4. Do not put volatile, flammable and explosive material nearby bath.
5. Moving parts may cause serious injury during operation. Make sure to put or remove containers in the basket after shaking motion is completely stop.



Caution :

1. Be careful not to spill liquid on the control panel.
2. Do not operate Shaking Water Bath without water in the bath.

2.4. Maintenance:-



Caution

1. Do not pour water or any liquid when you clean bath.
2. Do not use highly organic solvent for cleaning surface of bath.
3. Do not modify or alter electrical circuit or hardware.

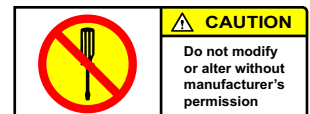

CHAPTER 3. FEATURE AND ADVANTAGE :

Labnics Shaking Water Bath is.....

ideal for laboratory experiment which needs to keep constant temperature range from ambient +5°C to 99°C and reciprocal motion shaking for agitation of samples to mix to accelerate reaction or aeration.

Labnics Shaking Water Bath has following features and specifications;

FRAME	SPCC metallic body with heavy duty epoxy powder coating in white and green /w Rubber foot
INTERNAL BATH	Stainless Steel 304 (AISI 304) Magnetic drain cap
LID	Lid: Stainless Steel 304 (AISI 304)
CONTROL SYSTEM	Integrated Digital PID microprocessor control system for temperature and speed Digital display of PV and SV for temperature, rpm and time Control of temperature, speed and timer independently or integral Timer: 99min 59sec / 99hr 59min / continuous time scale selectable Adjustable acceleration and deceleration speed in rpm/sec Class A pt100 control sensor
SAFETY	Adjustable over-temp. Cut-off safety: Thermostatic controller Over current cut-off: Electrical circuit breaker
ALARM SYSTEM	Audible and visual alarm system for; <ul style="list-style-type: none">● Over temperature● Shaking motion failure● Disconnection of sensor
STANDARD ACCESSORIES	Universal spring rack x 1ea Lid: Stainless Steel 304 (AISI 304) Operation manual

CHAPTER 4. SPECIFICATIONS:-

Model No.		LSWB-30T
Bath Capacity		30L
Temperature	Range	Ambient + 5°C~99°C
	Accuracy	± 0.1°C
	Uniformity	±0.3°C
Control	Controller	Integrated digital PID Controller with timer and auto-tuning
	Display	Dual 4 digit LED display
	Sensor	Pt 100 / Opto-electric feedback control
Shaking Speed		20~120 rpm / 25 mm stroke reciprocal motion / ± 1 rpm
Safety Device		Over temp. cut-off/Electrical leakage breaker
Dimensions (W x D x H) mm	Inner	500 x 300 x 190
	Outer	760 x 370 x 390
	Rack Usable	350 x 210 x 140
Material	Bath	Seamless stainless steel 304
	Body	Steel with epoxy powder coating
Catalog No.		10150501

CHAPTER 5. PARTS AND FUNCTIONS

5.1 Main Parts



5.2 Main Controller

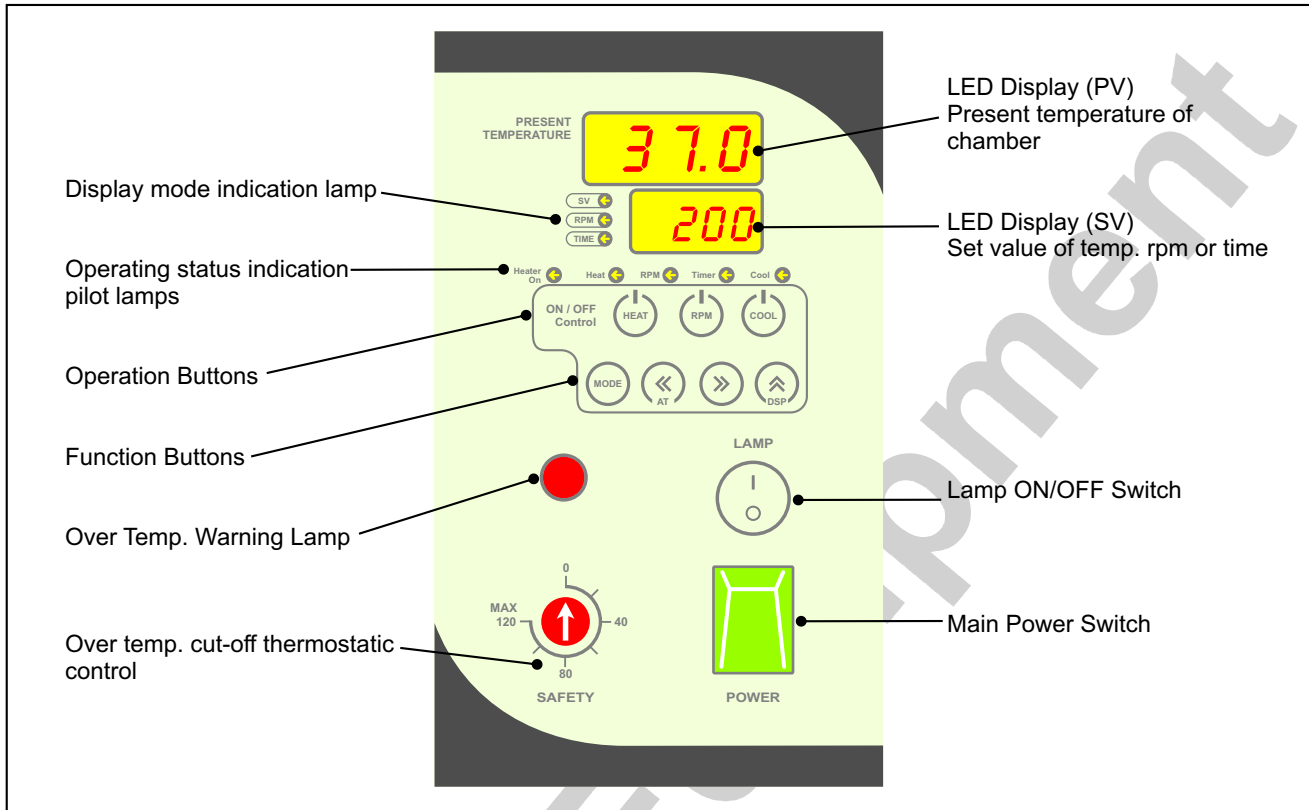

5.3 Main Controller Parts and Description

< DISPLAYS >

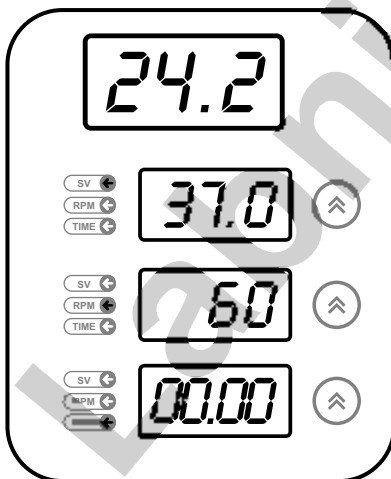

PV Digital LED Display

- PRESENT TEMPERATURE
- Displays present temperature in the bath

SV Digital LED Display

- Displays set value of temperature, rpm and time alternatively by pressing INC button
- Display mode indication lamp lit when SV displays temp. Rpm or time accordingly

[PILOT LAMPS]

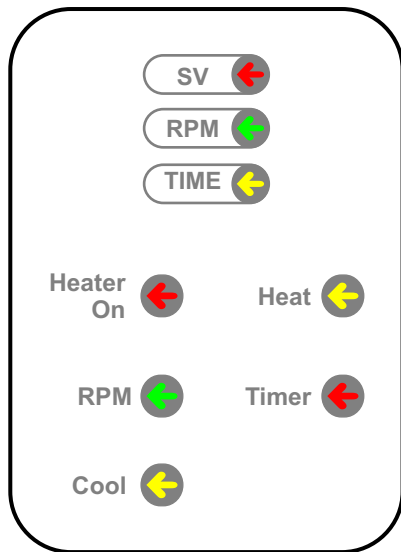

Display Mode Indication Lamp

- SV pilot lamp lit when SV LED displays set temperature
- RPM pilot lamp lit when SV LED displays set rpm
- TIME pilot lamp lit when SV LED displays time

Operating Status Indication Lamp

- **Heater On:** Turned on when controller give output to heater. ON and OFF during PID control
- **Heat:** Turned on when heating starts by pressing HEAT button
- **RPM:** Turned on when shaking starts by pressing RPM button
- **TIMER:** Turned on when user set wait-off timer and timer starts count down by press HEAT or RPM button
- **COOL:** No function on Shaking Water Bath

[OPERATION BUTTONS]

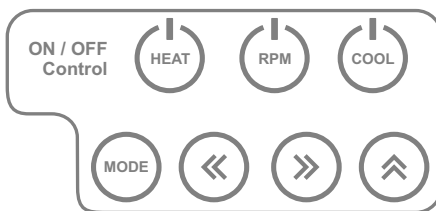

HEATER OUTPUT :

- Start and stop heating (Press to ON and press again to OFF)

RPM Button

- Start and stop shaking (Press to ON and press again to OFF)

COOL Button

- Your shaking Water Bath has no cooling system
- Button has no function

MODE Button

- Press to set temp. Rpm and time
- Press to set factory parameters. (See how to set factory parameters on SETTING PARAMETER section)

LEFT SHIFT Button

- Press to shift cursor to left digit when setting temp. Rpm or time.

AUTO-TUNING Function

- Press and hold for 5 seconds to start auto-tuning
- Your Shaking Water Bath was auto-tuned before shipment

About Auto-Tuning

The temperature of your Shaking Water Bath is controlled by precise PID Microprocessor controller. Controller automatically calculate optimum operating parameters such as P, I, A and D value. Auto-Tuning command enables to optimize temperature control.

When Auto-Tuning needed

Your Shaking Water Bath is auto-tuned before shipment. You do not need to auto-tune again before use. Auto-tune is necessary in case of

- Replacing heater (after replacing heater and check temperature stability. If temperature stability is ok, auto-tuning is not necessary).
- Replacing main controller (when you replace main controller, you have to auto-tune again).

How to start Auto-Tuning

- Input factory parameter as instruction.
- Set temperature at 40°C.
- Set rpm at 60 rpm.
- Press HEAT and RPM button to start temperature and rpm control.
- Press and hold LEFT SHIFT BUTTON for 5 seconds.
- LED displays blink indicating auto-tuning is starts with beep sound.
- Wait for 1 ~ 2 hours to finish auto-tuning.
- LED displays stop blinking with beep sound indicating auto-tuning is finished.
- Shaking Water Bath is auto-tuned again and ready to use.



RIGHT SHIFT Button

- Press to shift cursor to right digit when setting temp. Rpm or time.



INC Button

- Increase values by 1 increment.

DSP Function

- In normal display mode, press INC button to change display on SV LED display to show set temp. Rpm or time alternatively.

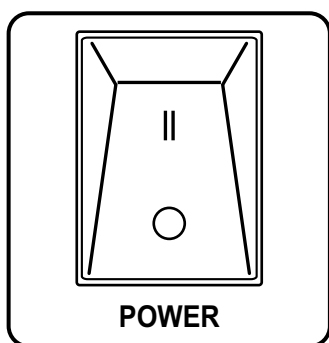
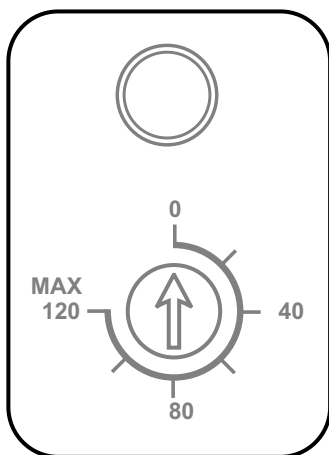

SAFETY LAMP/OVER-TEMP. CUT-OFF SAFETY THERMOSTAT

- Safety lamp turned on indicating current bath temperature is higher than over temp. Cut-off setting.
- Turn over temp, cut-off safety thermostat to 20% higher than normal operating temperature.
(Ex. Your operating temperature is 40°C, set safety thermostat at 60°C, if bath temperature increase higher than 60°C by any reason, thermostat automatically cut-off heater and lamp is turned on).

POWER SWITCH

- Main Power Switch.

CHAPTER 6. OPERATION:-

Before Operation:-

- 1) Check electrical requirement on the name plate before connect to consent.
- 2) Place your Shaking Water Bath on the flat and level surface.
- 3) Remove packing material in the bath.
- 4) Make sure to place shaking wire rack on the right position.
- 5) Connect power plug in rear panel to wall mount receptacle.

Getting Started:-

- 1) Pour water into the bath. Do not fill water over 60~70% of bath height.
- 2) Be careful not to be over flow during shaking motion.
- 3) Using deionized water is highly recommended.
- 4) Turn the circuit breaker on located on the back. Turn the **POWER** switch on. The **PV LED READOUT** displays current temperature of the bath.

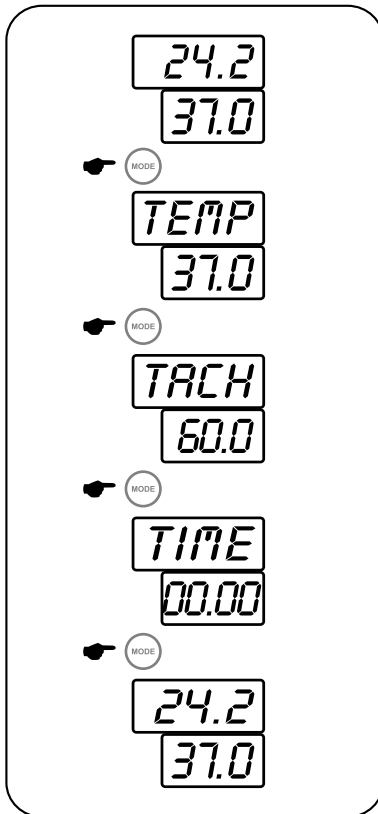

Setting Temperature, RPM and Time:-

- You can change operating temperature, rpm and time by using MODE button.
- Setting mode changes as left figure.

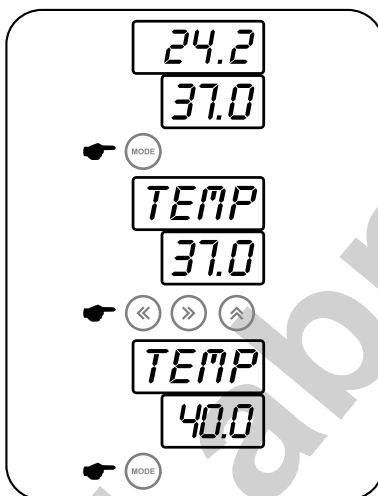

Setting Temperature:-

- 1) Press **MODE** button to set temperature in normal display mode.
- 2) **PV Digital LED** displays "TEMP" and **SV Digital LED** displays current SV temperature and prompt user input.
- 3) **Press SHIFT** button to move left or right digit.
- 4) **Press INC** button to increase or decrease value.
- 5) Temperature can be set from ambient +5°C to 99.9°C
- 6) **Press MODE** button again to go RPM setting.
- 7) **Press MODE** button twice to go normal display mode.

(Illus. showed how to change operating temperature from 37.0°C to 40.0°C).

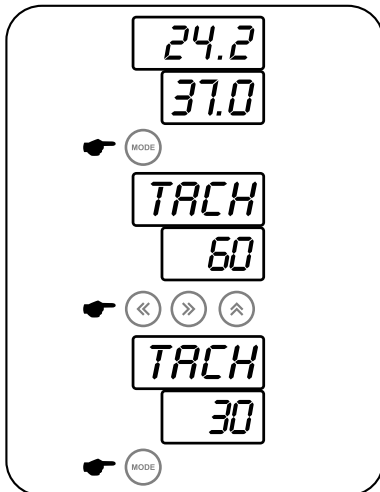

Setting RPM:-

- 1) Press **MODE** button twice to set RPM in normal display mode.
- 2) **PV Digital LED** displays " TACH " and **SV Digital LED** displays current SV RPM and prompt user input.
- 3) Press **SHIFT** button to move left or right digit.
- 4) Press **INC** button to increase or decrease value.
- 5) RPM can be set from 20 ~ 120 rpm.
- 6) Press **MODE** button again to go TIMER setting.
- 7) Press **MODE** button to go normal display mode.

(Illus showed how to change operating RPM from 60 to 30).

- Maximum operating RPM may less than specification When sample is loaded in the shaking basket. RPM may affected by weight of load or other operating Conditions.

Error Message (Err0)

If motor cannot be start within 15 seconds after pressing RPM button, controller warning error by audio visual message. Controller displays ERR0 and keep beep sound.

Press RPM button to escape from error status.

Trouble Shooting

Check any obstacle which may obstruct shaking motion.

Check total weight of sample loaded in the basket shouldn't exceed than maximum load (less than 15 kg).

Check basket is well positioned to move back and forth.

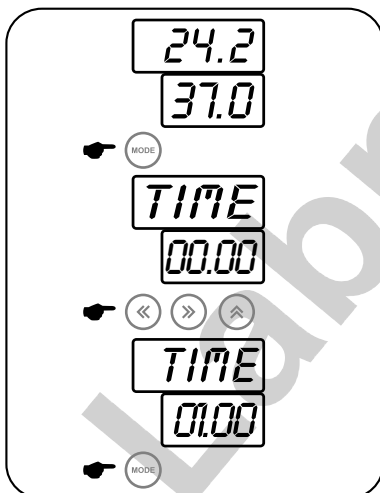

Setting Timer:-

- 1) Press **MODE** button three times to set timer in normal display mode.
- 2) **PV Digital LED** displays "TIME" and **SV Digital LED** displays current time and prompt user input.
- 3) **Press SHIFT** button to move left or right digit.
- 4) **Press INC** button to increase or decrease value.
- 5) For continuous operation set time at 00.00.
- 6) Timer can be set from 1 Min to 99 Hr 59 Min.
- 7) **Press MODE** button to go normal display mode.

(Illus. showed how to change operating time from continuous to 1 Hr).

- Time scale can be changed in min: sec.
Refer factory parameter setting to change time scale.

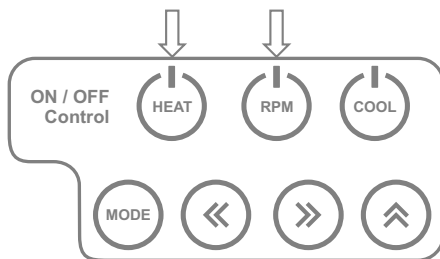
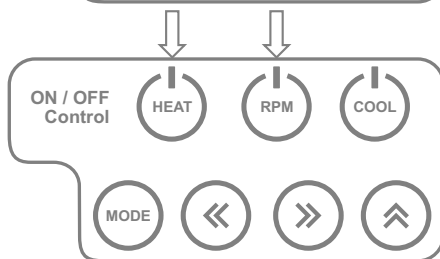
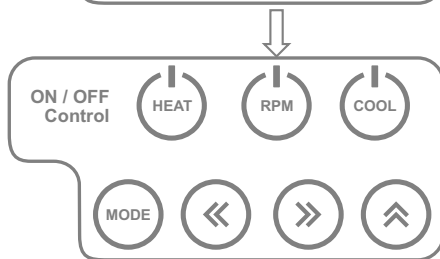
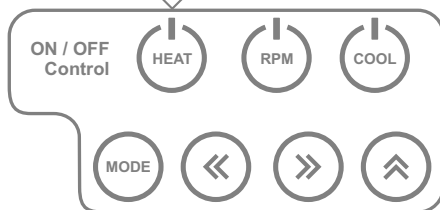
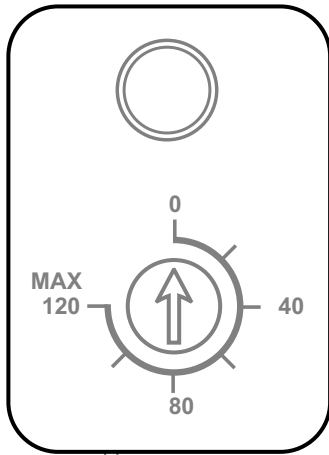

Over Temperature Protection:-

- 1) Safety lamp turned on indicating current bath temperature is higher than over temp. Cut-off setting.
- 2) Turn over temp, cut-off safety thermostat to 20% higher than normal operating temperature.
(Ex. Your operating temperature is 40°C, set safety thermostat at 60°C, if bath temperature increase higher than 60°C by any reason, thermostat automatically cut-off heater and lamp is turned on.).

Start temperature control only:-

- 1) **Press HEAT** button to start temperature control.
- 2) **Press HEAT** button again to stop temperature control.

Start shaking only:-

- 1) **Press RPM** button to start shaking.
- 2) **Press RPM** button again to stop shaking.

Start temperature control and shaking:-

- 1) **Press HEAT** and **RPM** button.
- 2) **Press HEAT** or **RPM** button again to operation.

Setting Timer with temperature and RPM control:-

Refer how to set timer to set wait-off timer.

Using timer with temperature only:-

- 1) Set operating temperature.
- 2) Set RPM at 000.
- 3) Set time to stop (ex. 01.00 for 1 hour operation and stop heating).
- 4) Press RPM button to count down timer.
- 5) Shaking Water Bath heat up to operating temperature and stop heating when time is up.
(N3 of MODE1 should be 0 in factory parameter to stop heating).
(If N3 of MODE1 is set at 1, controller keep heat up even though time is up).
(For continuous operation set time at 00.00).

Using timer with RPM only

- 1) Set operating temperature below present temperature.
- 2) Set RPM you want to operate.
- 3) Set time to stop (ex. 01.00 for 1 hour operation and stop shaking).
- 4) Press RPM button to count down timer.
- 5) Shaking Water Bath start shaking and stop when time is up.
(For continuous operation set time at 00.00).

Using timer with temperature and RPM

OPERATING MODE A: Keep operating temperature and stop shaking only when time is up.
(Set N3 of MODE 1 at 1)

- 1) Set operating temperature.
- 2) Set RPM.
- 3) Set time to stop (ex. 01.00 for 1 hour operation and stop heating).
- 4) Press **HEAT** button and press **RPM** button to start count down timer.
- 5) Shaking Water Bath heat up and start shaking.
- 6) When time is up, shaking stops and temperature keep at set temperature.
(N3 of MODE1 should be 1 in factory parameter to keep heating).

OPERATING MODE B: Stop temperature and shaking control when time is up.
(Set N3 of MODE 1 at 0)

- 1) Set operating temperature.
- 2) Set RPM.
- 3) Set time to stop (ex. 01.00 for 1 hour operation and stop heating).
- 4) Press **HEAT** button and press RPM button to start count down timer.
- 5) Shaking Water Bath heat up and start shaking.
- 6) When time is up, temperature control and shaking stops.
(N3 of MODE1 should be 0 in factory parameter to keep heating).

CHAPTER 7.FREQUENTLY ASKED QUESTION

7.1 Temperature keep increasing and decreasing under operating temperature

Cause: SAFETY setting is lower than operating temperature

Solution: Turn SAFETY setting clockwise higher than operating temperature

Cause : Alternation of optimum factory parameters

Solution: Auto-tune again

7.2 Temperature Overshoot

Cause : High room temperature

Solution: Your Shaking Water Bath has no cooling system. If room temperature is higher than 30°C, your bath cannot maintain less than 35.0°C. Use water bath in optimum operating condition

Cause: Heat generated by reaction or insulation

Solution: Open lid during operation so that water in the bath lose heat to ambient air

7.3 LED displays uuuu and beep

Cause: Over heat higher than 100°C. check water level

Solution: Your water bath cannot be used over 100°C. If temperature increase over 101°C, controller warning high temperature and cut-off heater

CHAPTER 8. TROUBLE SHOOTING

Error Symbol	Cause	Solution
uuuu	Over heat higher than 100°C	Call for Service
nnnn	Sensor disconnection	Call for Service
ErrO	Motor failure or shaking disable	Remove obstacle
		Lessen weight load
		Check motor

CHAPTER 9. SETTING FACTORY PARAMETERS:-

To set factory parameter A,

press and hold **MODE** Button for 5 seconds

Press **SHIFT** and **INC** Button to change values

Press **MODE** Button to go next parameter

To escape from Parameter mode to normal display mode, press and hold **MODE** Button for 6 seconds.

Factory Parameter A

Parameter Symbol	Name of Parameter	Setting Range and Descriptions	Factory Default	User Set Value
<i>BEEP</i>	BEEP ON TIME	0 ~ 99 SEC	30	
	Beep on time in seconds after timer is over. If the value is set at 0, continuously beep until press RPM button			

<i>ADJ</i>	Temperature Adjustment	- 99.9 ~ 299.9	Calibrated value	
	Compensate temperature deviation If the actual temperature measured by standard thermometer is different from temperature which controller read, user can compensate temperature difference by Adj function Ex) Actual temp = 100.0 Displayed temp = 99.9 SetAdj at 0.1 Actual temp = 99.5 Displayed temp = 100.0 SetAdj at - 0.5			
<i>COOL</i>	COOLER ON TEMP.	- 99.9 ~ T-Lt value	35	No function
	SET Temp. > Cool value -> Cooler relay off SET Temp. < Cool value -> Cooler relay on			
<i>ALH</i>	ALARM LIMIT HIGH No function	00.0 ~ 99.9	0.2	No function
<i>ALL</i>	ALARM LIMIT LOW No function	00.0 ~ 99.9	0.3	No function
<i>USLP</i>	Speed increment per second	1 ~ 59 RPM	5	Do Not Change
	Acceleration and deceleration rate when start up and stop shaking For smooth start-up and stop motion, keep this value high			
<i>HYS</i>	HYSTERESIS No function		0.2	No function
<i>FRPM</i>	Fix rpm speed display	0 ~ 99	5	
	Fix displayed operating RPM within a range. Control rpm drift			

<i>DLOC</i>	LOCK PASSWORD	0000, 1111	0000																															
	Protect set values and parameters from unauthorized change <table style="margin-left: 40px;"> <tr> <td></td> <td>N3</td> <td>N2</td> <td>N1</td> <td>N0</td> </tr> <tr> <td>Available value to set</td> <td>0 or 1</td> <td>0 or 1</td> <td>0 or 1</td> <td>0 or 1</td> </tr> <tr> <td>Where N3 : KEY LOCK</td> <td></td> <td>1 : LOCK</td> <td>0 : UNLOCK</td> <td></td> </tr> <tr> <td>N2 : RESERVED</td> <td></td> <td>1 :</td> <td>0 :</td> <td></td> </tr> <tr> <td>N1 : PARAMETER DATA LOCK</td> <td></td> <td>1 : LOCK</td> <td>0 : UNLOCK</td> <td></td> </tr> <tr> <td>N0 : SET VALUE DATA LOCK</td> <td></td> <td>1 : LOCK</td> <td>0 : UNLOCK</td> <td></td> </tr> </table> N3 (KEY LOCK): Protect pressing button. N1 (PARAMETER DATA LOCK) : Protect parameter values stored in the controller N0 (SET VALUE DATA LOCK) : Protect user set values such as temperature and time					N3	N2	N1	N0	Available value to set	0 or 1	0 or 1	0 or 1	0 or 1	Where N3 : KEY LOCK		1 : LOCK	0 : UNLOCK		N2 : RESERVED		1 :	0 :		N1 : PARAMETER DATA LOCK		1 : LOCK	0 : UNLOCK		N0 : SET VALUE DATA LOCK		1 : LOCK	0 : UNLOCK	
	N3	N2	N1	N0																														
Available value to set	0 or 1	0 or 1	0 or 1	0 or 1																														
Where N3 : KEY LOCK		1 : LOCK	0 : UNLOCK																															
N2 : RESERVED		1 :	0 :																															
N1 : PARAMETER DATA LOCK		1 : LOCK	0 : UNLOCK																															
N0 : SET VALUE DATA LOCK		1 : LOCK	0 : UNLOCK																															

<i>MODE2</i>	OPERATING MODE CONTROL	0000~1111	1000	
	Available value to set	N3 0 or 1	N2 0 or 1	N1 0 or 1
<p>Where N3 : DECIMAL PLACE DISPLAY 1 : YES (0.1oC) 0 : NO (1oC) N2 : ALARM HIGH DATA TYPE 1 : ABSOLUTE 0 : RELATIVE N1 : ALARM LOW DATA TYPE 1 : ABSOLUTE 0 : RELATIVE N0 : HEATER OUTPUT CONTROL WHEN DOOR OPEN 1 : HEATER ON 0 : HEATER OFF</p>				
<i>MODE3</i>	OPERATING MODE CONTROL	0000	0000	
	Available value to set	N3 0 or 1	N2 0 or 1	N1 0 or 1
<p>Where N3 : RESERVED N2 : RESERVED N1 : ALH 1 : START RELAY OFF 0 : START RELAY ON N0 : RESERVED</p>				
<i>CTOM</i>	Defrost cycle time in minutes			No function
<i>CTOF</i>	Defrost duration time in minutes			No function
<i>CDLY</i>	Delay time of compressor start			No function
<i>DRAN</i>	Fix drift of temperature display within the set value		0.5	
	<p>Temperature drifts during operation owing to several reasons. To eliminate temperature drift, set DrAn value to fix temp. within the value</p>			
<i>DTOM</i>	Fix drift of temperature display within the set value during defrost			No function



Labnics Equipment
43040 Christy St., Fremont, CA 94538 USA.
Toll Free : (877) 620 9992
Tel. : (925) 271 4322
Fax : (925) 886 0400
Email : info@labnics.com
Website : www.labnics.com