

# Standard Chamber Furnace



## Instruction Manual



**Model : LSCF Series**

Please read this manual carefully before using the instrument

**Labnics Equipment**

---

# Table of Content

<b>SR. NO.</b>	<b>CONTENT</b>	<b>PAGE NO.</b>
<b>A.</b>	<b>INTRODUCTION</b>	<b>1</b>
<b>B.</b>	<b>INFORMATION RELATED TO SAFETY</b>	<b>1</b>
1.	Unpacking & Handling of the Furnace	1
2.	Electrical Safety	2
3.	Human Health and Environmental Safety	3
<b>C.</b>	<b>GENERAL INFORMATION</b>	<b>3</b>
1.	Technical Details	3
2.	Furnace Components & Related Technical Properties	4
3.	What is PID Control?	9
4.	Points to Take Care While Operating the Furnace	9
5.	Hints	10
5.1.	Repairs & Replacements	10
5.2.	Calibration	12
5.3.	After Sale Services	12
6.	Frequently asked questions	12
<b>D.</b>	<b>OPERATING PROPERTIES</b>	<b>13</b>
<b>E.</b>	<b>SAMPLE PROGRAM</b>	<b>17</b>
<b>F.</b>	<b>SERVICE REPORT</b>	<b>20</b>

## A. INTRODUCTION

This booklet includes our recommendations, hints and points of notice for you to have a safe and better service from this equipment. We kindly ask you to carefully read this manual and only then to operate the furnace.



This insignia is used for the purpose of warning you against risks involved. Read carefully the notes when this sign is noted.



The insignia is to warn you for any risk of damage to this equipment.



This insignia warns you of the hints to use this equipment in better terms.

## B. Information Related To Safety

### 1. Unpacking and Handling of the Furnace

Before operating the furnace please take note of following points.

- This furnace has been packed to minimize any risk due to transportation. Remove the packing with care; avoid using any kind of force and removing packing inserts slowly.



It is extremely important to remove the packing inserts from inside the furnace. Operating the furnace without removal of safety inserts will cause heavy damage on the heating elements.

- Use furnace base while lifting and carrying the furnace.
- Always use two persons to carry.
- Always take note of the weight of furnace during placement.
- Do not operate the furnace if there is inflammable material around. Ensure that the risk of fire is non-existent. Do not place the furnace on an inflammable surface.
- Placement should be in a well ventilated room, with no interaction with other sources of heat. Do not place on an inflammable surface.



Air circulation, should be capable enough to remove any gas emission due to come through the lid or furnace chimney. Almost all gas emissions during operation can be hazardous for Human health

- Always give space of 30cm around the furnace to enable quick service. Do not close the vents on the furnace body. These are required to cool down the system.

## 2. Electrical Safety

### 2.1 Electrical Connections

Due to safety none of the Labnics furnaces that use over 16 amps have a plug while delivery. Main connection of furnace over 16 amps should be managed through a circuit breaker and according to electrical diagram supplied together with this manual.



Electrical plugs even at low amperes (< 16amps) are prone to create electrical arcs. We therefore strongly recommend using a circuit breaker of appropriate amperes rather than the plug.



Any electrical connection to operate this furnace must be done by a Qualified Electrician .Accordingly any repairs or maintenance job requires a qualified technician.



The technician who is responsible of commissioning the furnace is also responsible to act in accordance the rules of safety of European Community. Technician is solely responsible of selection and use of appropriate circuit breaker and earth connections.

#### Single Phase Electrical Connection

Cable Color	Supply	Terminal Label
Brown	Phase	L
Blue	Neutral	N
Green-Yellow	Earth	E

#### Triphase Electrical Connection

Line number	Supply	Designation of Lines
1	Phase 1	L1
2	Phase 2	L2
3	Phase 3	L3
4	Neutral	N
Green-Yellow	Earth	E



- Power supply must be close enough to enable the operator to cut off power easily in case of emergencies.
- Mains connection must incorporate an earthed isolating cut off switch.



Never use an electrically conductive tool within the furnace while in operation

### 3. Human Health and Environmental Safety

1. Do not operate this furnace while there is any live substance in it.
2. Do not operate this furnace with flammable, explosive, poisonous etc. materials (Hydrogen, LPG, Acetylene, Arsenic, TNT, Gunpowder etc.) inside. Labnics does not accept any responsibility in case of any accident which might happen during any kind of process due to the usage of materials mentioned above.
3. Do not contact or get in close proximity with flammable or explosive materials while this furnace is operating or hot.
4. If at any times, this furnace is to be used under conditions of hazard to Human health, the sole responsibility belongs to Operator. During such operation Operator is obliged to provide the necessary conditions to minimize any risks involved.
5. If the lid of furnace is to be opened for a short cool down, any risks involved due to hot discharge of air, belongs solely to Operator. We strongly advice of notification of personnel around, against risks, to avoid any burns etc.
6. Labnics furnaces are manufactured in conformity with CE Electromagnetic Emissions Directive. Even though so electromagnetic emissions can effect some sensitive equipment such as Hearth Pace Batteries. Any one carrying such batteries should avoid close contact with this furnace.

## C. General Information

### 1. Technical Details

Model	Max. Temperature	Heat Up Time	Useful Volume W x H x D	Inner Dimensions W x H x D	Outer Dimensions	Power (kW)	Temp. deviation at Set Point	Phase
		Max. Temperature less 100°C (Min.)						
LSCF-100A	1100°C	65	7,5L	18x21x20cm	65x55x58cm	2,0	+/-2°C	1
LSCF-100B	1100°C	45	15L	23x22x30cm	72x56x67cm	4,0	+/-2°C	1
LSCF-100C	1100°C	45	28L	25x28x35cm	79x55x70cm	4,0	+/-2°C	1
LSCF-200	1150°C	100	6.5L	11x21x28cm	65x55x58cm	2,7	+/-2°C	1
LSCF-300A	1200°C	60	7,3L	14x20x20cm	65x55x58cm	2,0	+/-2°C	1
LSCF-300B	1200°C	50	12L	20x20x30cm	72x56x67cm	4,0	+/-2°C	1
LSCF-300C	1200°C	70	18L	23x23x35cm	79x55x70cm	4,0	+/-2°C	3
LSCF-300D	1200°C	80	27,4L	28x28x35cm	79x55x70cm	4,5	+/-2°C	3
LSCF-400A	1300°C	50	9L	18x20x25cm	72x56x67cm	4,0	+/-2°C	1
LSCF-400B	1300°C	60	15L	23x23x30cm	72x56x67cm	4,0	+/-2°C	1
LSCF-400C	1300°C	50	24,6L	27x27x35cm	79x55x70cm	6,0	+/-2°C	3

LSCF-500A	1400°C	70	9L	18x20x25cm	72x56x67cm	4,0	+/-2°C	1
LSCF-500B	1400°C	125	32,5L	27x25x48cm	77x60x70cm	12,0	+/-2°C	3
LSCF-600A	1500°C	75	7L	14x20x25cm	72x56x67cm	4,8	+/-2°C	3
LSCF-600B	1500°C	95	15L	22x22x31cm	77x60x75cm	9,0	+/-2°C	3
LSCF-600C	1500°C	125	29,7L	27x25x44cm	77x60x70cm	12,0	+/-2°C	3
LSCF-700A	1600°C	75	6,9L	17x17x24cm	65x55x58cm	5,3	+/-2°C	3
LSCF-700B	1600°C	95	15L	22x22x31cm	77x60x75cm	10,0	+/-2°C	3
LSCF-700C	1600°C	14	27,3L	26x25x46cm	77x60x70cm	12,5	+/-2°C	3

\* The heat up times mentioned are approximate values established at 25°C medium temperature

\*\* Labnics is entitled to change the technical properties of the furnaces manufactured at will and without informing.

## 2. Furnace Components & Related Technical Properties

### 2.1 Temperature Controllers

Model	Sensitivity	PID	Step definition	Number of Programs	Number of Segments
DC 1010	1°C	✓	-	-	-
PC442/2	1°C	✓	✓	1	2
PC442/6	1°C	✓	✓	1	6
UDC 2500	1°C	✓	✓	1	12
PC442/18	1°C	✓	✓	1	18
PC442 MP5	1°C	✓	✓	5	20
PC442/MP20	1°C	✓	✓	20	30

- Data concerning the Configuration Parameters are placed to controller during set up. These parameters define many details such definition of thermocouple type, temperature scale, PID values etc.
- All configuration parameters of the control system are "read only". Changing these parameters can have a detrimental effect to operation of furnace. If, any such intervention is to be made Labnics must be informed beforehand and asked to provide a written consent.

## 2.1.1 Honeywell DC1010



Almost all Controllers employed have a short period of self test during which any interference is not possible . Please wait till this test is over .



### A) General Notes Regarding Application

**PV (Process Variable):** Displays the actual temperature of the furnace

**SP (Set Point):** Displays the targeted (set) temperature

LEDs , OUT1,OUT2,AT,AL1,AL2,AL3,MAN & PRO, display the active functions of the controller

Insignia	Description	Active Color
OUT1-OUT2	Output Relays (power) are active	Green
AT	Auto Tune is underway	Orange
AL1-AL2-AL3	Alarm signal underway	Red
MAN	Controller is operating under Manual Mode	Orange
PRO	Controller is operating under Programme	Orange

**SET Key :** Used to enter values and/or opens submenus available .

◀ Key : Used to move across the digits.



“◀” when presser the first digit on the panel will start flickering.  
 “▼” and “▲” keys are used to determine the Set Temperature.  
 Press SET” key to finalize the procedure

▼ key : Used to increase or to activate a Function

▲ key : Used to decrease or to pasifize a Function

## B) Honeywell DC1010

DC1010 controller does not feature any programming capacity but can be used to set a temperature only. The controller will reach predefined temperature and will dwell indefinitely.

### 2.1.2 Honeywell UDC2500

#### Programming Hints

UDC 2500 controller has 3 programming modes:

SPRate, SPRamp, SPProg

All can be used as required but SPProg is capable of managing the other two.



To run any programming mode, it has to be enabled by pressing either “up” or “Down” keys. Only one of the modes can be enabled

Due to cancellation of manual key on display any programming profile has to have the cooling stage defined as well.



Use a paper to draw your program profile before data feed in.



- We advice the PVSTART option to be enabled to ease the running of program
- While running the program, you will observe the display flashing “RUN” from time to time.
- If display key is pressed during a RUN ,various info regarding the program will be displayed

### 2.1.3 PC442

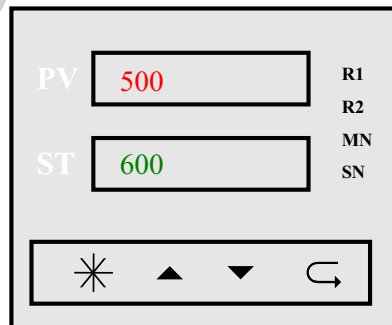

#### A) General Introduction concerning the controller

**PV** : Display of actual temperature at operational page and error messages otherwise

**ST** : Display of Set Temperature and/or number of program running as well as the program step .

**R1, R2, MN, SN, PV ve ST** LEDs show the active functions (or inactive functions) of the controller



Insignia	Related Technical Explanation
R1	R1 Relay LED turns on when energized ( usual operational relay)
R2	R2 Relay LED turns on when energized
MN	Turns on when Controller is in Manual mode (normally off)
SN	Turns on at increments of 1 secs when a program is running

\* Key : Used to return to beginning of a menu, to return Mains Menu or transition between manual control mode and programmable mode.



Please note that, if you press "\*" key only once in a certain menu it takes you to beginning of that menu.

if you press "\*" key continuously in a certain menu it takes you to main menu.

if you press "\*" key continuously in programmable control mode it takes you to "manual control mode"

if you press "\*" key continuously in manual control mode it takes you to "programmable control mode"

Please check Section D.



Key: Used to proceed to next parameter



Key: Used to either to increase a value or to activate a function .



Key: Used to either to decrease a value or to inactivate a function

## 2.1 Heating Elements



Labnics employs Kanthal originated heating elements in furnaces.

### 2.2.1 Wire elements

The basic advantages of Kanthal APM and Kanthal A1 quality elements are:

1. High creep resistance at high temperatures.
2. High resistance against corrosive atmospheres.
3. Limited change of resistivity during service life.

### 2.2.2 SiC Heating Elements/ Effect of Atmosphere

For furnaces over 1400°C Labnics furnaces use Kanthal Gobar series SiC heating elements. SiC elements are non-metal based and give higher resistivity as well as high temperature application. Furnaces that use SiC heating elements are dispatched without the elements installed to minimize the risks of breakage during transport. SiC elements are fragile and are prone to breaking if mishandled. Use only an experienced technician while installing the elements. It is also important to note the effect of firing atmosphere on the elements. SiC elements are normally operated in Air, although numerous laboratory applications require use of other atmospheres.

This may cause significant chemical reactions to occur eventually leading to affect the life of elements. Operator must remember that SiC elements always prefer to have oxidizing atmospheres. This is due to the fact that a protective layer of silica glazing is built up to protect the elements against further oxidation.

Atmosphere	Crusilite	Globar SG	Comments
Air	1575°C	1650°C	Must be dry & clean
Vacuum	1000°C	1100°C -1300°C	Depends on degree and period of the application
Nitrogen	1250°C	1400°C	
Exothermic/ Endothermic Gas	1000°C -1250°C	1250°C -1400°C	Very variable ,depends on dew point and gas composition
Hydrocarbons	1250°C	1250°C	Periodic burn off required

### 2.2.3 MoSi<sub>2</sub> Heating Elements

Kanthal Super is a unique material combining the best properties of metallic and ceramic materials. Like metallic materials it has a good heat and electric conductivity and like ceramics it withstands corrosion and oxidation and has a low thermal expansion. It is not affected by thermal shock and is strong enough to withstand many years of service as a heating element. The resistance of Kanthal Super elements does not change due to ageing even after having been in operation for a long time at high temperatures. Due to these properties a failed element can easily be replaced without the performance of other elements connected in series being influenced.



Kanthal Super elements are extremely brittle. In order to minimize the damage risk during the transportation 1700°C furnaces are sent without their elements assembled. Please use an experienced technician while installing the elements.

## 2.2. Refractory Insulation

Labnics employs only modern heat insulating materials which can be defined as fiberboards and insulating bricks. Modern insulation materials are capable of very efficient heat insulation as well as giving a very low mass. Still at commissioning these materials emit a disturbing gas which may be felt at only first heat up. Most of these discharge takes place during tests at manufacturing stage, even so if any felt during first use, please do not think this to be a problem.

## 2.3. Electrical Layout

Labnics employs electrical components fit for CE regulations during production. Furnaces do have all necessary safety cut off precautions if there need be.

### 3. What is PID Control?

The simplest way of temperature control is On/Off. On/Off Controlling supplies full power till a predetermined Set point is reached and power is turned off after this threshold is reached, turning on again when temperature drops down. Temperature is never stable, only fluctuating at around the set point. Due to full power use, temperature over shoot is unavoidable especially at lower temperatures where heat loss is minimal. PID, Proportional-Integral-Derivative Control systems supply power as much as necessary and limits applied power as actual temperature gets closer to set temperature. Microprocessor keeps the temperature rise (heat up) under control through continuous input measurements and as the difference in between Actual and Set temperatures gets closer power employed decreases which in the end over shoots are very limited even at lower temperatures. Temperature control is stabilized after initial over shoot if there is any. For sensitive temperature control PID algorithm is essential.



PID values are supplied by Labnics during production tests. Do not modify PID data as this might lead to serious negative results.

### 4. Points to Take Care While Operating the Furnace

1. Every furnace has a specified maximum temperature and it should never be used over this temperature.



The heating elements and the concerned insulation are related with furnace 50°C below the maximum temperature to have a longer element life. Never use a furnace over its designated maximum temperature.

2. Labnics LSCF series furnaces are manufactured to operate under oxidizing conditions. Designated maximum temperatures may be limited if operated under other atmospheres, please consult the experienced technician in this case.
3. Insulation materials used are affected negatively by hydrofluoric acid and strong alkali presence. If by any means there is a discharge of strong alkali gases please consult as the furnace lining maybe modified accordingly.
4. Furnace lid should be opened as little as possible and for shortest periods possible at high temperatures.



As furnace gets closer to limit temperatures thermal shock risks related to lid opening increase. Especially the SiC elements are prone to risks of thermal shocks.



Labnics furnaces employ a power cut off system when the lid is opened. You will hear noise of the concerned contactor opening when the lid is opened. Strongly, we advice you to use a non-conducting material when interfering with hot furnace to avoid burns.

5. We recommend the use of furnaces with SiC heating elements without any shut downs, kept at stand by at around 400°C when unoperational. This procedure will increase the service life of SiC heating elements. Furnaces with wire heating do not require any such precautions and can be turned off whenever required.



Whenever a breakage occurs of SiC elements, user has to change it in pairs, keeping the unbroken one in stock. It is not possible to use an old SiC element together with a new one.

The old unbroken element should be kept aside to be used in pairs with an old element.



At high temperatures a glassy phase coating appears on SiC elements. This coating although not harmful to elements may fracture and disintegrate to small pieces of glass if handled. For reasons of safety use a glove and eye glass while handling old SiC elements.

6. A hearth plate is provided with every LSCF series furnace which has the purpose of preventing any spill over to furnace base. Operator is obliged to use the base plates during operation and to replace it when contaminated.
7. At any heat treatment application operator must take care to get rid of any grease on metal parts by application of degreasing chemicals before heat up. Otherwise the tar fumes can accumulate on the elements which may lead to a short circuit leading to eventual break down of element.
8. For LSCF series furnaces of over 1400°C, a standard over temperature alarm system is employed to protect the SiC elements. If ever over temperature increase occurs, this alarm system cuts off the power by means of disengaging a contactor.
9. Keep organic solvents and water away from insulation material.
10. Keep metal slag away from heating elements to avoid a short cut.
11. Labnics furnaces are not designed for heating food and operator should not use the furnace for cooking purposes.
12. Heating elements usually give a long service life but are basically for consumption. They will have to be replaced after a reasonable period of use.

## 5. Hints

### 5.1. Repairs & Replacements

#### 5.1.1. Maintenance

1. Although periodic maintenance is not required if the furnace is operating frequently it will be wise to clean up the air vent from time to time
2. For cleaning purposes a wet & soft piece of cloth can used but do not use any organic solvents as it may effect the epoxy paint.

## 5.1.2 Repairs

### A) Replacement of Wire Heating Elements

Regarding the LSCF series furnaces change of heating elements are quite easy and can be changed by User. To change the heating elements please use following procedure,

1. Disengage the Mains



Make sure there is no power on the Equipment!

2. Open the back lid of the furnace
3. Open the terminal connections



Take note to write down the colors of the cables before dismantling, use the same combinations to reinstall after change of elements.

4. Remove the thermocouple
5. Remove the all electrical leads to terminal connections
6. Remove the wire element from ceramic tube carriers within the furnace
7. Slide the new wire element onto the ceramic carriers and place the ceramic tube carrier into their corresponding slots. Isolate the terminals as before and reverse the rest of disassembly process.
8. Reheat the furnace to 900°C to observe it functioning.



During repairs, do not interfere with electrical layout of the furnace. Consult to electrical diagram of the furnace supplied together with this manual



Use installment manual supplied to change the SiC elements.

### B) Replacement of Solid State Relay

Always disengage power before opening the back panel. Use proper screw driver and remove the back panel or control box. Disconnect the relays, taking note of connection diagram and coloring of wires. Remove the disfunctioning relay using a screw driver and place the new one to the related rail. Close the back panel and heat up the furnace till 900°C.

### C) Replacement of Thermocouple

Always disengage power before opening the back panel. Use proper screw driver. When there is thermocouple break down, the controller always gives a related warning at display. When there is a problem with it remove the metal support of thermocouple and remove the cables noting the coloring of connecting cable. Remove the thermocouple slowly taking note not to break the ceramic sheath if there is any. Reverse the process and heat up the furnace.

## 5.2. Calibration

Depending on using frequency and application temperature, you may require a calibration of the thermocouple from time to time or even a change of the thermocouple. For K type thermocouples we advise a change for every year. For S or R type thermocouples the useful life can be much longer for temperatures less than 1500°C. At applications close to 1600°C, a change of thermocouple every year is also advised.

## 5.3. After Sales Services

Labnics manufactures robust furnaces so that after sales are kept at minimum. Even so we have engineers that will provide you any service you require. Most of the time problems encountered can quite sufficiently be solved by technical assistance through internet or by phone. Please always inform of the serial number for better analysis of the problem. For an easier problem solving please note following "fault analysis" questions.

## 6. Frequently asked questions / Fault Analysis

### 1. Furnace controller does not display when the I/O switch turned on?

- 1.1. Check the Mains supply. Check the voltage present .May be less than 220V
- 1.2. Check the fuses on your mains supply.
- 1.3. Check the glass fuse at side of furnace; it may be broken during transport.
- 1.4. Check the power supply of temperature controller
- 1.5. Check the main fuses, after opening the back panel.

### 2. Furnace does not heat up when the "heat" I/O switches turned on? The Heat lamp is not operating?

- 2.1 PV value is higher than SP value. Increase the Set temperature.
- 2.2. Heating element may have failed.
- 2.3. Thermocouple may have failed (Controller display must be showing a warning) or the connection cables may be disconnected. See warnings below
- 2.4. SSR may have failed and needs replacement.
- 2.5. The lid switch may have failed.

Model	T/C failure sign
Honeywell DC1010	in I E
Honeywell UDC2500	IN1FL
PC442 Series	Err.I

### 3. Display shows a higher temperature than the limits of furnace?

- 3.1. There may be an SSR failure, ON.
- 3.2. Configuration of the controller may have been changed by someone.

**4. Thermocouple shows a low temperature**

- 4.1 The thermocouple may have been shorted or may have been moved from its original place
- 4.2 Thermocouple may be reverse connected
- 4.3 Controller may be have a faulty configuration

**D. Operational Properties**

**1. Electrical & Other Requirements**

Phase	Volts	Frequency	Medium Temp.	Humidity
Single	220V	50Hz	5°C-40°C	Max.%85
Triphase	380/220V	50Hz		

**2.1.1 Control Panel (Honeywell DC1010 & UDC2500)**

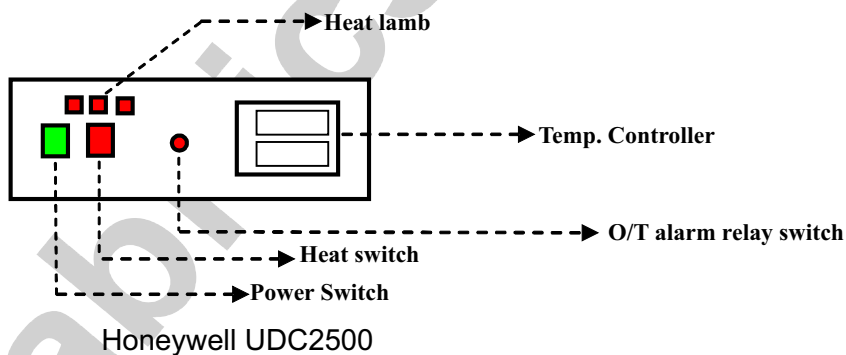
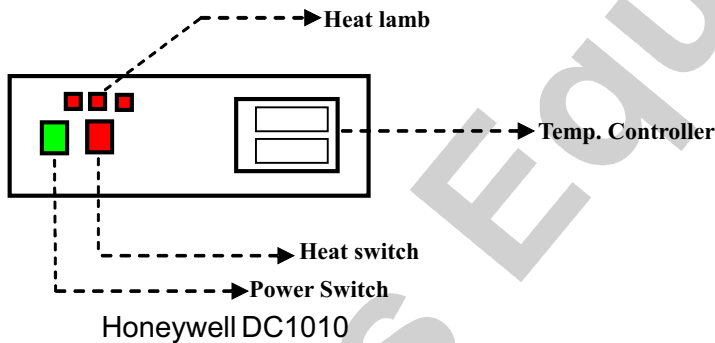

-  • O/T alarm relay switch appears only for high temperature furnaces (T>1400°C)
- Single phase furnaces have single "heat lamp"

To operate the furnace:

1. Turn on the Green I/O switch. This will open the controller panel but the furnace will not start heating. The purpose of this is to give time to operator to feed in programming data / set the required temperature etc. without actually the heat up.
2. To start heating turn on the red "heat" I/O switch and if all normal, you will observe the "heat lamps" lighting on and off.

### 3. Limit Controller

Labnics optionally provides Limit Controller as a means of Over Temperature safety. Limit Controller through as a separate thermocouple, has the purpose of cutting off the heating of furnace whenever the predetermined limit temperature is exceeded. The Limit Controller also will not let the furnace reheat even if furnace cools down to lower than the limit temperature. To restart heating, operator has to press the "Reset Button" on the control panel. Honeywell DC1010 Limit Controller is very easy to use. In order to set the desired limit temperature press "◀" key then the first digit of the SP value will begin to flicker (Other 3 digits can be activated by pressing "◀" key.). By using "▲" and "▼" keys you can define the digits of the desired limit temperature. After you have entered the limit temperature value please press "set" key in order to make the entered data valid.

### 4. Timer

Labnics optionally provides timer, in order to let the furnace shuts down automatically as it reaches the set point and the time defined by the operator consumed. In order to set the timer, please follow the steps below.

1. Use a proper screw driver to adjust the time unit (sec, min, hrs, 10hrs) by turning the screw positioned at the down right hand side of the timer.
2. Use a proper screw driver to adjust different time values on the quadrant by turning the screw positioned at the down left hand side of the timer.
3. Red needle selects the time value. Turn the transparent cylinder to select the necessary time value.
4. Adjust a set temperature on the temperature controller.
5. Turn the red heat switch on.
6. Furnace will shut down after it reached the set temperature the dwell time selected on the timer consumed.



Please note that, the switch which is placed at the up right hand side of the timer defines the operation mode of the timer. Please Do not change the operation mode. It always has to be in the A mode.

## 2.1- THE CONTROL PANEL (PC442)

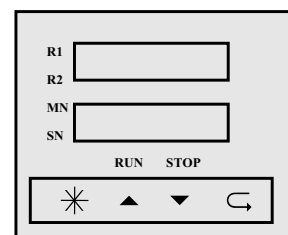
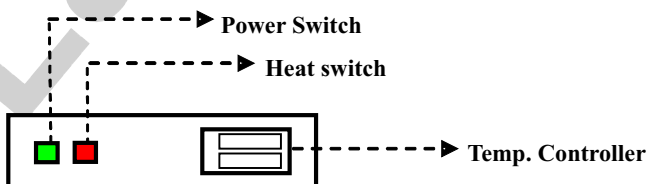

Fig.1. General Apperance of the Control Panel

Fig.2. General Apperance of the Temperature Controller





Please note that there are two different heating methods that the operator may choose in order to heat the furnace.

**1-Manual Heating Mode:** Simply enter the set temperature using “▲” and “▼” keys in the manual mode and open red the I/O switch. Furnace will start heating directly to set temperature.

**2- Programme Mode:** See Section C page 11 and Section D page 15 for further details.

Press \* key continuously for transition between the modes

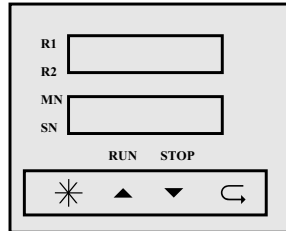

MANUAL CONTROL MODE MAIN DISPLAY

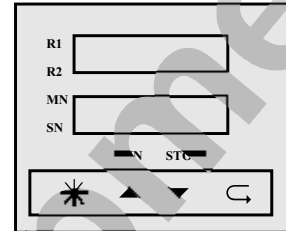

PROGRAMMABLE MODE MAIN DISPLAY

## 2.2 - OPERATING INSTRUCTIONS - SETTING THE START TIMER & STARTING A PROGRAM

3. Turn the Green Switch on, to enable the mains supply.

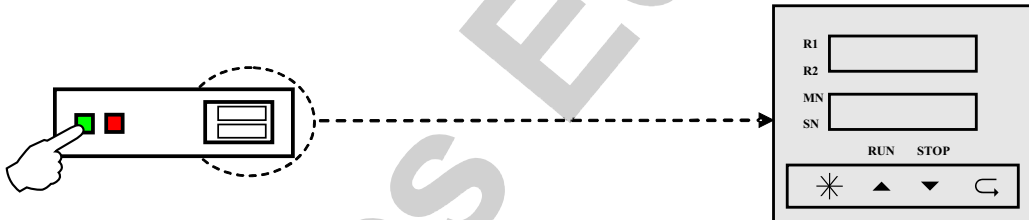

After the pre-open test is completed, controller will show the furnace temperature on the upper display and the selected program number on the lower display. Please note that the first program is pre-selected.

1. If you require a delay time before the programme starts, press “↻” key one by one until “Dly” is displayed on the screen. Adjust the dwell time in minutes by using up / down keys and press “\*” key once in order to return the main display.

Please note that if the start timer function is defined, 01:00 will displayed on the lower screen after the programme has started indicates that, the chosen programme will start after the dwell time has expired.

2. Use “▲” or “▼” key to select the requested recipe (program) number

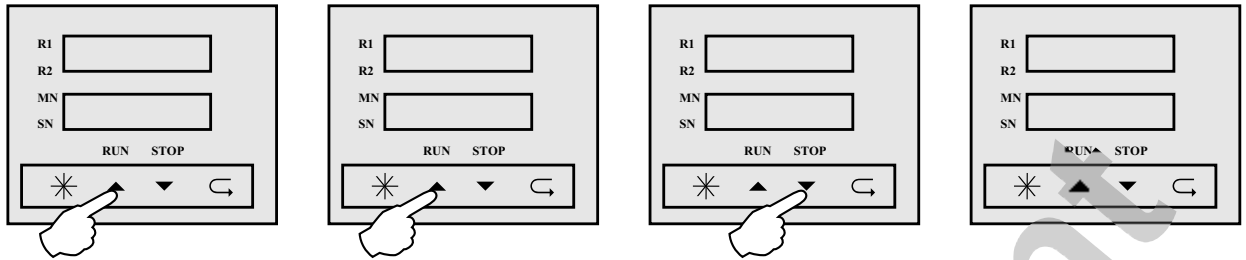

Please note that program number changes as the operator press “▲” or “▼” keys.

- Once a programme is chosen, in order to run the selected programme, first press “\*” key and then quickly press “▲” key while still keeping “\*” key pressed. The programme will display now the segment number as well “01:01”, First programme first stage.

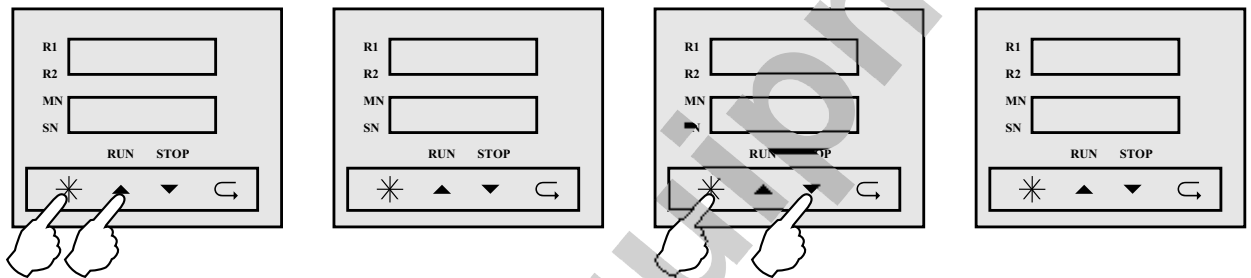

In order to cancel the programme, first press “\*” key and then quickly press “▼” key while still keeping “\*” key pressed.

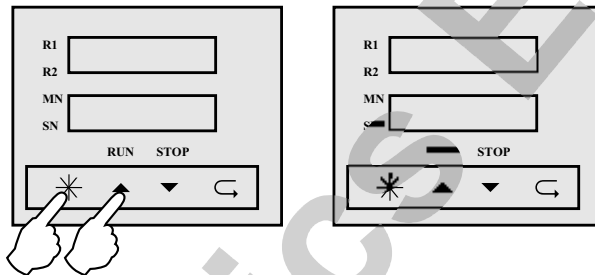

Please note that if the start timer function is defined, 01:00 will displayed on the lower screen after the programme has started after the dwell time has expired.

- After all the adjustments completed, turn the Red I/O Switch on, and you will observe the "heat lamps" lighting on and off.

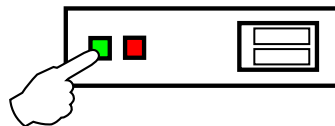

- You will observe the actual temperature at upper display of the furnace and the program number and stage (segment) number at the lower display.
- Program will start from the process value and carry on according the program data.
- During the program is running, by pressing "N" key one by one, you can reach certain information regarding the program which are all read only except "Dly" and "StSP".

8. These are : "StSP" determines the set point value during any of the programmes is not running, "Dly" determines the delay time at the start of a programme, "nr" number of repeats , "rst" remaining set time (Is the start timer is defined shows the remaining dwell time) , "psp" program set point , "coL" control out put limit , "setn" over temperature alarm limit and "Hys" set point hysteresis .
9. To "cancel" the program press \* and down key again and the program will be cancelled.
10. When activated Protherm PC442 does not stop even at power cut offs ,it will simply start to follow the programme when the power is reinstated . In that case you will see the "appr" sign on the lower display.
11. Please note that ,you can not change the programme data during operation.

## E. Sample Program (Honeywell UDC2500)

There are four different alternatives in order to heat up the furnace with UDC2500 Temperature Controller:

1. **Standard Heating**
2. **To define a ramp rate to reach a set point.**
3. **To define a time period to reach a set point.**
4. **Programming.**

In "**Standard Heating**", the set point can be adjusted by the operator by using the "▲" and "▼" keys on the Controller Panel and the furnace heats up this temperature with maximum power (uncontrolled) after the "heat" switch turned on .

Operator may either choose SPRate or SPRamp defines to heat up the furnace. However, SPProg can easily perform the function of SPRate and SPRamp.

### 4. Programming

#### Programming Steps

1. When you are in main display, press the "**SETUP**" button one by one until **SPRAMP** displays on the screen.
2. Press "**FUNCTION**" button to enter the sub-menu of the **SPRAMP** .
3. Keep pressing "**FUNCTION**" button until the **SPPROG** displayed on the screen.
4. Press "▲" or "▼" button and enable the **SPPROG** function. And make sure that the "**SPRATE**" and "**SPRAMP**" functions are disabled.
5. After you have enabled the **SPPROG** press "**FUNCTION**" button.
6. Now you are in the sub menu of the **SPPROG**.
7. In this menu, the functions which are listed at the **Prompt** column of the table will be displayed respectively if you press "**FUNCTION**" button step by step.
8. Now, please follow the steps that are shown at the table below.
9. **ALWAYS DEFINE A COOL DOWN SEGMENT TO ROOM TEMPERATURE AT THE END OF THE PROGRAM. OTHERWISE, AFTER THE PROGRAM HAS COME TO AN END THE FURNACE TEMPERATURE WILL STABILIZE AT THE LAST SEGMENTS TEMPERATURE VALUE UNTIL THE POWER IS TURNED OFF.**

Prompt	Function	Segment	Value
STRSEG	<ul style="list-style-type: none"> <li>Starting Segment</li> <li>The segment number which the program will begin.</li> <li>You may adjust the values with respect to functions mentioned in this table by pressing "▲" or "▼" button.</li> <li>Always, press "FUNCTION" button to confirm the value and to pass to next step.</li> </ul>	-	1
ENDSEG	<ul style="list-style-type: none"> <li>End Segment</li> <li>The segment number which the program will end.</li> </ul>	-	max.12
RPUNIT	<ul style="list-style-type: none"> <li>Engineering Unit for Ramp.</li> <li>Defines heating up or cooling down speed.</li> <li>Can be chosen as TIME (Hr:Min) EU-H (°C/hr) EU-M (°C/min)</li> </ul>	-	TIME
PGEND	<ul style="list-style-type: none"> <li>Controller Status</li> <li>Do not change default value</li> </ul>	-	LAST SP
STATE	<ul style="list-style-type: none"> <li>Controller State at the end</li> <li>Do not change default value</li> </ul>	-	HOLD
TOBEGIN	<ul style="list-style-type: none"> <li>Reset SP Program</li> <li>Do not change default value</li> </ul>	-	DIS
PVSTRT	<ul style="list-style-type: none"> <li>Program Starts at PV Value</li> <li>Enable the function by pressing "▲" or "▼" button.</li> </ul>	-	ENB
RECYCL	<ul style="list-style-type: none"> <li>Number of Recycles</li> <li>Defines how many times will the program will repeat.</li> </ul>	-	0
SOKDEV	<ul style="list-style-type: none"> <li>Deviation Value</li> <li>Do not change default value</li> </ul>	-	0
SG1RP	<ul style="list-style-type: none"> <li>Ramp Time</li> <li>Defines the heat up time between two set points (SP)</li> <li>Units are: <ol style="list-style-type: none"> <li>Hr:Min if TIME option is adjusted in the RPUNIT menu. (TIME in this example)</li> <li>(°C/hr) if EU-H option is adjusted in the RPUNIT menu</li> <li>(°C/min) if EU-M option is adjusted in the RPUNIT menu</li> </ol> </li> </ul>	1	1 hr
SG2SP	<ul style="list-style-type: none"> <li>Soak SP</li> <li>Defines the set point which the furnace will heat up in this segment.</li> </ul>	2	300

	<ul style="list-style-type: none"> <li>Unit is °C</li> </ul>		
SG2TI	<ul style="list-style-type: none"> <li>Soak Time</li> <li>Defines the waiting time at the set point</li> <li>Unit is Hr:Min</li> </ul>	2	1hr:30min
SG3RP	Ramp Time	3	1hr
SG4SP	Soak SP	4	400
SG4TI	Soak Time	4	1hr
SG5RP	Ramp Time	5	1hr:30min
SG6SP	Soak SP	6	250
SG6TI	Soak Time	6	3hr:0min
SG7RP	Ramp Time	7	2hr:30min
SG8SP	Soak SP	8	500
SG8TI	Soak Time	8	0hr:30min
SG9RP	Ramp Time	9	0
SG10SP	Soak SP	10	400
SG10TI	Soak Time	10	0hr:30min
SG11RP	Ramp Time	11	3hr:30min
SG12SP	Soak SP	12	200
SG12TI	Soak Time	12	0hr:30min

**The Sample °C- Time Program**

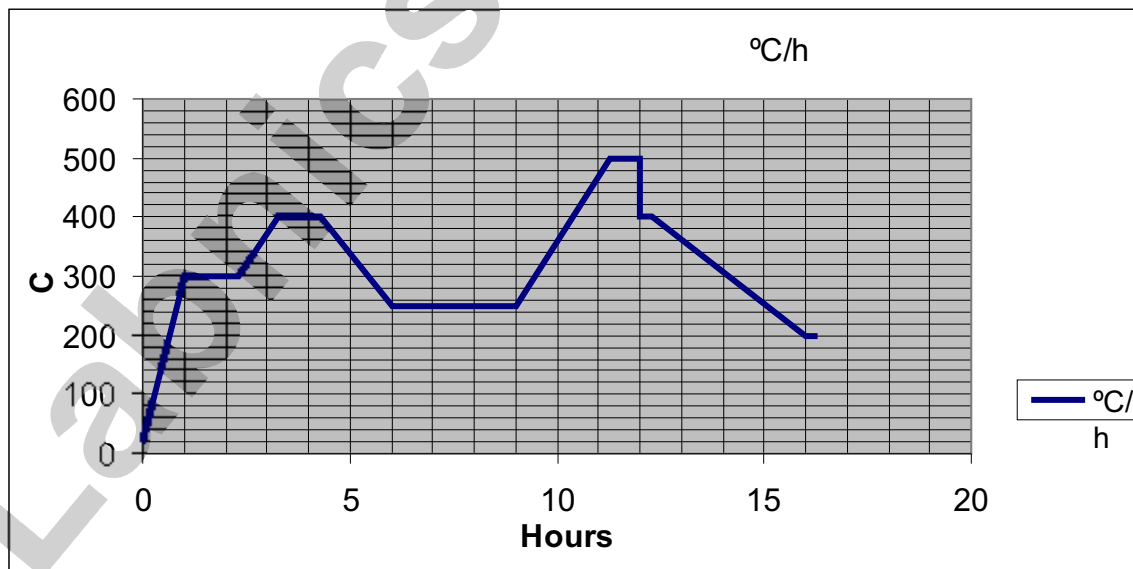





**Labnics Equipment**  
43040 Christy St., Fremont, CA 94538 USA.  
Toll Free : (877) 620 9992  
Tel. : (925) 271 4322  
Fax : (925) 886 0400  
Email : [info@labnics.com](mailto:info@labnics.com)  
Website : [www.labnics.com](http://www.labnics.com)