

# **Autoclave / Sterilizer**



## **Instruction Manual**



**Model : LAC-40**

**Please read this manual carefully before using the instrument**

**Labnics Equipment**

---

# Table of Content

CHAPTER	CONTENT	PAGE NO.
1.	Before Use	1
2.	Safety Precaution	1
2.1	Safety	1
2.2	Power connection	4
2.3	Installation	4
2.4	operation	4
2.5	Maintenance	5
3.	Feature and Advantage	5
4.	Specifications	7
5.	Parts and Functions	7
6.	Main Controller	9
7.	Operation	11
7.1	Before Operation	11
7.2	Preparation of Material	11
7.3	Getting Started	12
7.4	How to set Temperature	13
7.5	How to set time	13
7.6	Start Sterilization	13
7.7	Finishing Sterilization	15
7.8	Auto-tuning	15
8.	Service Manual	16
8.1	Draining and refilling water	16
8.2	spills	16
8.3	Changing water	16
8.4	Electric control panel	17
8.5	Electric Problem	18
8.6	Pressure pipe lines	18
9.	Setting Parameters	18
9.1	Parameter 1	19
9.2	Parameter 2	20
10.	Inspection Log	22
11.	Service Report	23

## CHAPTER 1. BEFORE USE:-

Thank you for choosing **Labnics** Products

Please read this operation manual carefully before use for your safety and optimum operating performance.

If you have any question, please contact sales representative or service department.

## CHAPTER 2. SAFETY PRECAUTION:-

This manual contains important operating and safety information. You must carefully read and understand the contents of this manual prior to the use of this equipment.



### **Warning:-**

Warning alert you to a possibility of personal injury



### **Caution:-**

Caution alerts you to a possibility of damage to the equipment.

**Your Autoclave/Sterilizer using high temperature steam and high pressure.**

**If you are not trained for Autoclave usage or not familiar with Autoclave, please do not operate before you are trained or completely read this manual and understand about your Autoclave for your health and safety and to prevent personal injury.**

**If you do not understand, please contact your laboratory supervisor or technician for further training course or advise.**

**LABNICS IS NOT RESPONSIBLE FOR ANY DAMAGE OF PROPERTY OR PERSONAL INJURY FOR ABUSE OR USAGE FOR WRONG PURPOSE OF AUTOCLAVE**













### **2.1 Safety**

Autoclaves are such a familiar feature in many laboratories that it is easy to forget what hazards they can pose. The autoclave's job is to render its contents sterile, or free of any living organisms. If it fails to do so, serious health hazards can result. The hot, pressurized steam (121°C, 1.2 kg/Cm<sup>2</sup> in gauge) that autoclaves generate to do this job makes them serious burn hazards as well. And, because conditions created inside steam autoclaves are so extreme, autoclaves can easily malfunction if they are not carefully.

Before using **Labnics** Product. **Labnics** autoclave for the first time read and thoroughly understands the owner's manual. If you cannot locate the manual, contact local distributor or us directly to get a copy.

## KEEP WARNING FOR YOUR SAFETY

	DO NOT OPERATE WITHOUT WATER INSIDE OF THE CHAMBER HEATER IN THE CHAMBER SHOULD BE IMMERSSED IN THE WATER TO PREVENT OVER HEATING OR MALFUNCTION
	IF THERE IS NO WATER IN THE CHAMBER DURING OPERATION THE AUTOCLAVE WILL MOMENTARILY OVERHEAT. THIS MAY CAUSE MALFUNCTION OF AUTOCLAVE
 <b>HOT</b>	DURING OPERATION, ANY PART OF THE AUTOCLAVE TOUCHING THE TOP OF THE AUTOCLAVE OR COVER MAY RESULT IN SEVERE BURNING. <ul style="list-style-type: none"><li>- cause by contact with the outside of autoclave</li><li>- caused by contact when removing autoclaved items</li><li>- caused by contact with pressurized steam</li></ul>
 <b>HOT</b>	KEEP AWAY FROM AUTOCLAVE AT LEAST 50 cm during OPERATION TO PREVENT BURNING CAUSED BY LEAKAGE OF STEAM.
	WARNING - BURN HAZARDS CLOGGING LINES, EQUIPMENT MALFUNCTION OR FAILURE IN THE STEAM SUPPLY MAY CAUSE THE AUTOCLAVE CHAMBER TO FILL WITH SCALDING WATER. IF THE WATER LEAKS FROM ANY PART OF THE AUTOCLAVE, DO NOT OPEN THE CHAMBER DOOR. BURNS FROM SCALDING WATER MAY OTHERWISE RESULT.
	POTENTIAL EXPOSURE TO INFECTIOUS AGENTS THROUGH EITHER AIRBORNE, DROPLET OR CONTACT TRANSMISSION
	WHEN PROCESSING LIQUIDS, USE ONLY FLASKS AND SELF-VENTING AUTOMATIC SEALING STOPPERS RECOMMENDED BY THE MANUFACTURER. THIS WILL HELP TO PREVENT SEALED FROM EXPLODING AND LIQUIDS IN GLASS CONTAINERS FROM RUPTURING.
	WASTE THAT CONTAINS BLEACH MAY HARM AN AUTOCLAVE
	CAREFULLY PREPARE ITEMS FOR AUTOCLAVING. LOOSELY COVER OR CAP CONTAINERS TO AVOID OVER-PRESSURIZATION
	KEEP LOADS SMALL - OVERLOADING HINDER STEAM PENETRATION.

	BAGS SHOULD BE OPEN AND SHOULD BE CONTAINED WITHIN THE STAINLESS STEEL TRAY OR BASKET.
 <b>HOT</b>	AFTER COMPLETELY VENTILATED, OPEN CHAMBER DOOR ABOUT ONE CENTIMETER AND ALLOW TEN MINUTES TO LET THE LOAD COOL BEFORE REMOVING TRAY.
 <b>HOT</b>	ALL STEEL PARTS OF AUTOCLAVE ARE HOT. DO NOT TOUCH DURING OPERATION OR STERILIZATION CYCLE.
	NEVER AUTOCLAVE NITROCELLULOSE TUBES - THEY CAN EXPLODE ! DO NOT PUT FLAMMABLE, VOLATILE OR EXPLOSIVE MATERIALS INSIDE OF THE CHAMBER
	DO NOT REMOVE THE GROUND PRONG (THIRD PIN) (IN CASE OF 110V) FROM THE POWER CORD, OR USE AN UNGROUNDED ADAPTER. THE AUTOCLAVE REQUIRES A 3-WIRE RECEPTACLE. IF ONE IS NOT AVAILABLE, CONSULT WITH AN ELECTRICIAN FOR INSTALLATION.
	THE MAIN VOLTAGE MUST CORRESPOND TO THE VOLTAGE GIVEN ON THE NAME PLATE. YOUR AUTOCLAVES ARE 120VAC 60HZ OR 220VAC 50/60HZ SINGLE PHASE
	TO REDUCE THE RISK OF ELECTRICAL SHOCK, DO NOT OPEN THE BODY. NO USER SERVICEABLE PARTS INSIDE.
	PLACE AUTOCLAVE ON THE FLAT AND LEVELED SURFACE BE SURE TO CONNECT DRAIN AND STEAM VENTILATION VALVE TO DRAIN SINK
	USE DISTILLED WATER ONLY TO PROTECT HEATER AND SENSOR
	CHANGE WATER IN THE CHAMBER FREQUENTLY TO PREVENT CONTAMINATION AND ODOR. USING AUTOCLAVE DEODORANT RECOMMENDED
	DO NOT OPEN THE CHAMBER DOOR AT ANY TIME UNTIL THE PRESSURE GAUGE INDICATING ZERO (0)
	OPEN "MANUAL SAFETY PRESSURE RELEASE VALVE" ENTIRELY EVERY TIME OPEN THE CHAMBER DOOR AFTER OPERATION

## 2.2 Power Connection



1. Your Autoclave is designed for 110VAC 60Hz 1P or 220VAC 50 / 60Hz Single Phase.
2. Check electrical requirement on the name plate before use. Name plate is located in electric cord connection.

Model	Electrical Requirement	Amp	Phase
LAC-40	220~240 VAC 50/60Hz	2 kW 10 AMP	Single Phase

3. Connect to receptacle with ground connection.
4. Make sure to supply enough electrical current.
5. The powder socket and plug for LAC-40 is 220VAC SINGLE PHASE. DO NOT connect to 380VAC THREE PHASE.

## 2.3 Installation



1. Install autoclave where water supply and water drainage is possible.  
Your autoclave using water for steam sterilization, it is highly recommended to install on a place where water supply and water drainage is convenient.
2. Do not use in high humid environment or install beside delicate instruments.  
Your autoclave generates heat and steam during operation, it may damage other delicate instruments.
3. Install autoclave oven at least 100mm apart from side and back wall.  
Steam and drain water from the back of autoclave.
4. Place flat, rigid and leveled surface.
5. When moving autoclave do not up-side-down.
6. Do not place any object on the top of autoclave.

## 2.4 Operation



1. Hot surface may cause serious injury. Always wear protect gear during operation.  
Do not contact surface of autoclave especially hatch door without protective gear. Hot surface may cause serious injury.  
Do not open door during operation when pressure engaged in the chamber  
Be careful hot steam when you open hatch door after sterilization cycle.
2. Do not put volatile, flammable and explosive material inside of autoclave
3. Do not put volatile, flammable and explosive material nearby autoclave.



1. Do not operate without water in the autoclave chamber.
2. Be careful not to spill water to control panel.
3. Use distilled water or deionized water.

## 2.5 Maintenance



1. Do not pour water or any liquid when you clean autoclave
2. Do not use highly organic solvent for cleaning surface of autoclave
3. Drain water and refill fresh water in the chamber after sterilization cycle to prevent contamination.

## CHAPTER 3. FEATURE & ADVANTAGE

### **LABNICS AUTOCLAVE IS.....**

For sterilization of bacteria, microorganism and virus with steamed hot air usually at 121°C, 1.2 kgf/cm<sup>2</sup>.

Sterilization for laboratory ware needs being sterilized before use such as flasks, bottles, pipets animal cages and plastic ware, broth or agar media for bacterial culture or disposal of biohazard wastes such as syringe, cloth, gloves or Petri dishes.

### **Feature**

1. Vertical loading with service basket.
2. Stainless Steel 304 (AISI304) interior, lid and top to protect from corrosion by water and steam.
3. Incoloy heating element, provides long life, resistant to corrosion and high temperature in repeated use.
4. Manual air purge and bleed valve
5. Automatic air inlet purge valve
6. Mechanical over pressure safety valve prevents the pressure surpassing the set maximum limit.
7. Over-temperature security disconnects the heating element in the event of over temperature or over pressure surpassing the set maximum limit.
8. Over temperature thermostat disconnects power to the heating element in the event of over temperature or the lack of water in the reservoir.
9. Electric circuit breaker for electrical safety.
10. Digital PID controller precisely controls the set temperature within  $\pm 0.5^{\circ}\text{C}$  and sterilization time in min:sec.
11. Set temperature, time and pressing start button automatically finish sterilization cycle and alarm end signal when sterilization cycle is finished.
12. Dual LED displays current temperature and set temperature or remaining time simultaneously.
13. Pressure gauge

14. Equipped with drain valve for convenience.
15. Adjustable needle valve which can control exhaust pressure depending on it's application.

## **Specifications**

### **FRAME**

- SPCC metallic body with heavy duty epoxy powder coating in white and green
- 10mm thick SPCC metallic top plate to be assembled with chamber, hinge, latch and door
- Stainless Steel 304 (AISI304) top cover
- Four casters with stopper

### **INTERNAL CHAMBER**

- Stainless Steel 304 Polished (AISI 304) 3 mm thick.
- Stainless Steel door with silicone rubber packing.
- Incoloy heater.
- Drain valve.

### **CONTROL SYSTEM**

- Digital PID microprocessor control system
- Auto-tuning
- PV & SV Dual 4-Digit LED Digital Display
- Wait-Off Timer : 59min59sec / continuous
- Automatic sterilization cycle

### **SAFETY SYSTEM**

- Pressure Gauge
- Mechanical over pressure safety valve prevents the pressure surpassing the set maximum limit.
- Over-temperature security disconnects the heating element in the event of over temperature or over pressure surpassing the set maximum limit.
- Over temperature thermostat disconnects power to the heating element in the event of over temperature or the lack of water in the reservoir.
- Electric circuit breaker for electrical safety.

### **ALARM SYSTEM**

- Audible and visual alarm system for over temperature and over pressure.

### **Standard Accessories**

- Perforated Basket : 2 EA
- Instruction Manual : 1 EA



## CHAPTER 4. SPECIFICATIONS

<b>Model</b>		<b>LAC-40</b>
Dimensions (W x D x H) mm	Inner	300 x 620H
	Outer	620 x 460 x 950
Capacity		40 l
Heater		2.0 kW
Temperature	Range	Ambient + 5oC to 123°C
	Accuracy	±0.5°C at 121°C
	Uniformity	±2.0°C at 121°C
Display		PV & SV Dual Digital Display
Controller		PID Multi-Function Controller
Timer		59min59sec / continuous
Material	Inner	Stainless Steel (SUS304)
	Outer	Powder Coated Steel
Operating Pressure		1.2 kg/cm
Safety		Over Heat Protector Over Current & Leakage Breaker
Electric Supply		110V, 60Hz or 220 V, 50/60 Hz

## CHAPTER 5. PARTS AND FUNCTIONS

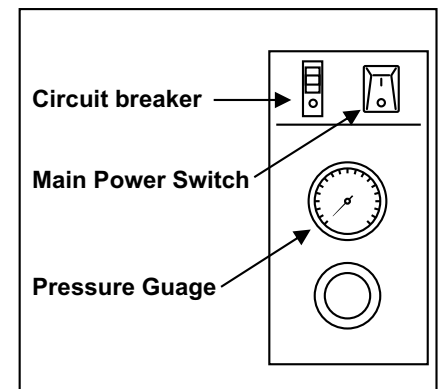
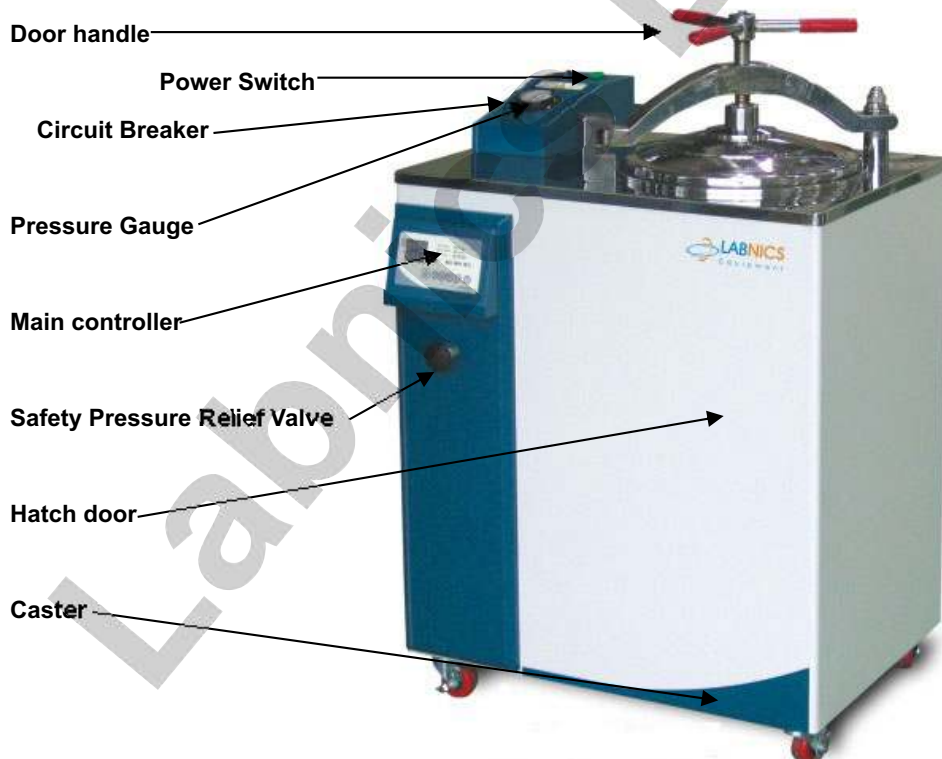

## MAIN POWER SWITCH

- Turn electrical power on.

## PRESSURE GAUGE

- Gauge indicates pressure in the chamber. Usual maximum operating pressure is 1.25 kgf/cm<sup>2</sup>.
- Make sure the pressure gauge indicates 0 (zero) every time before opening door.

## Pressure Range and Characteristics

Pressure	0 ~ 1.2 kgf/cm <sup>2</sup>	1.2 ~ 1.4 kgf/cm <sup>2</sup>	> 1.4 kgf/cm <sup>2</sup>
Range	Preheating Pressure	Sterilization Pressure	Danger
Color	Yellow Zone	Green Zone	Red Zone
Characteristic	within this range, autoclave preheating to increase pressure and temperature to enter sterilization cycle	within this range, chamber temperature is 121~124°C for sterilization.	Over this range steam can be leak and explode around the chamber door
Action	No sterilization	Sterilization	Press STOP to stop heating Press STOP to vent out steam Open Manual Safety slowly

### What to do when pressure increase over > 1.4 kgf/cm<sup>2</sup> (Dangerous Range)

- 1) Press STOP Button to cut off heating and venting out pressure from the chamber
- 2) Open Manual Safety Pressure Relief Valve Slowly. If you open valve quickly, pressure suddenly increase to explode
- 3) DO NOT turn off MAIN POWER SWITCH that will close SOLENOID VALVE to prevent over pressure venting
- 4) Leave Autoclave until the pressure down to 0 kgf/cm<sup>2</sup>
- 5) Leave Autoclave to cool down to ambient temperature
- 6) Contact your local technical service engineer

## MANUAL SAFETY PRESSURE RELEASE VALVE

- Open the valve and release pressure to 0 (zero) in the chamber every time opening door for user safety.
- Open slowly.
- When the pressure in the chamber would not release automatically, user can lower pressure in the chamber manually.

## DOOR HANDLE

- Turn the handle clockwise tightly to lock the door before operation

## DOOR

- Close door tightly and on the correct position

## STEAM OUTLET

- Steam and pressure is releasing to the Drain Outlet after sterilization cycle is finished.
- **Avoid body contact to prevent injury because hot and high pressure steam is exhausting from the valve during operation.**

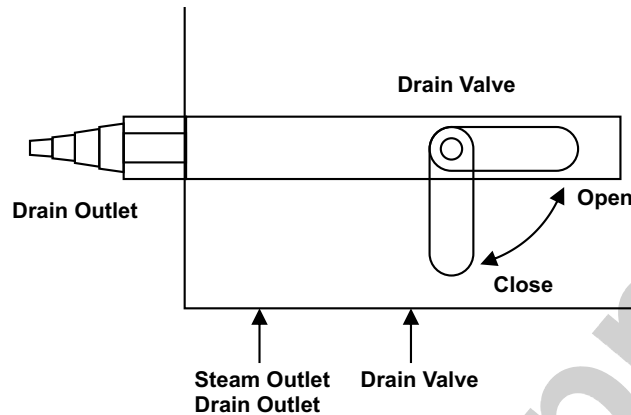

## DRAIN VALVE

- Open the valve to drain water in the chamber
- Drain valve is inside of the door located on left side of autoclave.
- Do not open drain valve when there is pressure engaged in the chamber

## CHAPTER 6. MAIN CONTROLLER

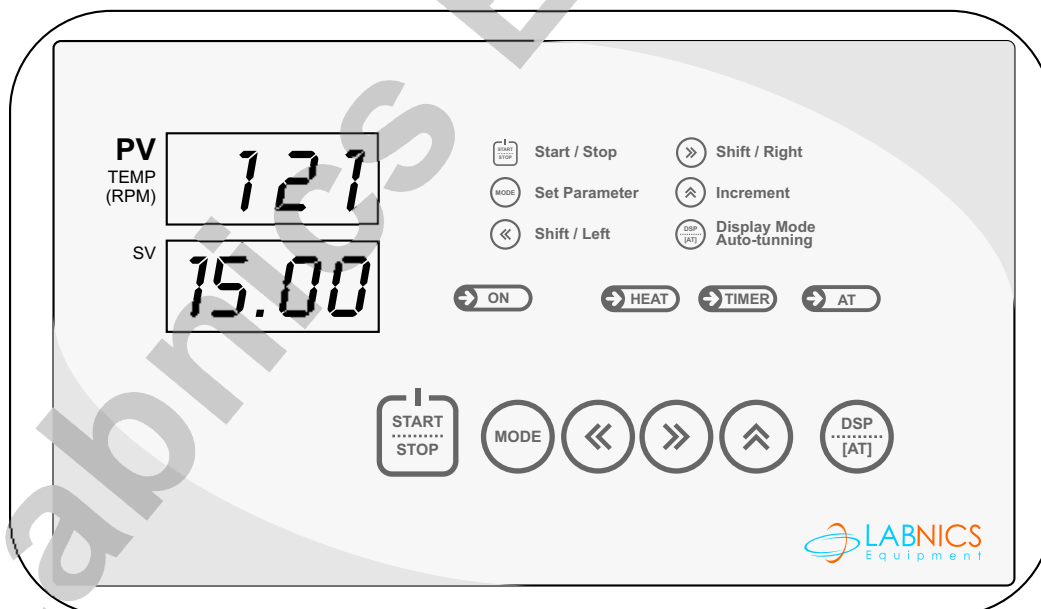

## [DISPLAY]

### **PV (Process Value) LED Display**

- Displays current temperature of the chamber

### **SV (Set Value) LED Display**

- Displays user set temperature (SV) or remaining time to finish
- Press DSP to show SV temp. and time alternatively.

## [PILOT LAMPS]

### **ON LAMP**

- Lamp blinks during operation.

### **HEAT LAMP**

- Lamp glows when heater is on. Lamp blinks during operation.

### **TIMER LAMP**

- Lamp glows when user input timer value.
- Lamp blinks when press START until PV reach to SV temperature.
- Lamp stop blinking and glows when PV reach to SV temperature.

### **AT LAMP**

- Blinks during auto-tuning.

## [BUTTONS]

### **START/STOP BUTTON**

- Start and Stop operation.

### **MODE BUTTON**

- Push to change user set values.

### **SHIFT BUTTON**

- Move cursor to left to change values.

### **SHIFT BUTTON**

- Move cursor to right to change values.

### **INC BUTTON**

- Change set values by 1 increment.



### **AUTO-TUNE**

- Display set value of time and temperature alternatively.
- Press and hold to start Auto-Tuning.

## CHAPTER 7. OPERATION

### 7.1 Before Operation

- 1) The main voltage must correspond to the voltage given on the name-plate.
- 2) Place Autoclave on the flat and level surface.
- 3) Connect steam outlet (drain valve) to silicone tubing and extend to drain sink.

	DO NOT REMOVE THE GROUND PRONG (THIRD PIN) (IN CASE OF 110V) FROM THE POWER CORD, OR USE AN UNGROUNDED ADAPTER. THE AUTOCLAVE REQUIRES A 3-WIRE RECEPTACLE. IF ONE IS NOT AVAILABLE, CONSULT WITH AN ELECTRICIAN FOR INSTALLATION
	YOUR AUTOCLAVES ARE <b>120VAC 60HZ OR 220VAC 50/60HZ SINGLE PHASE</b>
	TO REDUCE THE RISK OF ELECTRICAL SHOCK, DO NOT OPEN THE BODY. NO USER SERVICEABLE PARTS INSIDE

### 7.2 Preparation of Material

- 1) All materials must be autoclavable.
- 2) Vessels are loosely capped.
- 3) Liquid contained in a vessel is at least twice the volume of the liquid to be autoclaved.
- 4) All materials are placed in an autoclavable tray with sides at least 4 inches high.

All materials autoclaved must be placed in an autoclavable tray with sides that are at least 10 cm in height. The use of trays should eliminate anything boiling over and spilling into the autoclave. Therefore, all materials must fit within this tray. Only autoclavable materials may be placed in the autoclave. If you are unsure if something is autoclavable, check with the local distributor or contact us directly.







Liquids to be autoclaved must be in an autoclavable vessel that is at least twice as large as the volume to be autoclaved (i.e. If you are autoclaving 1 liter of media, you need to put it in a flask that hold at least 2 liters). This allows for boiling during the cycle. Caps must be slightly loose so that pressure created during the cycle does not cause the vessel to break. For screw cap containers you can make the lid hand tight and then loosen the lid by one-half turn.

Dry goods must be placed in an autoclavable tray with 10 cm sides also. Garbage must be put in autoclavable bags and inside the autoclavable trays with 10 cm sides. Sharps containers must also go into the same type of autoclavable trays. To ensure proper sterilization of both garbage and sharps containers, 1 liter of water should be added to the bags or sharps containers.

This water will vaporize during the autoclave cycle to allow better penetration of steam and more efficient sterilization. Autoclave garbage bags must be tied off.

**Warning:** Use of non-autoclavable trays and containers may result in injury to the user and damage to the equipment.



## WARNING and SAFETY PRECAUTION

	POTENTIAL EXPOSURE TO INFECTIOUS AGENTS THROUGH EITHER AIRBORNE, DROPLET OR CONTACT TRANSMISSION
	WHEN PROCESSING LIQUIDS, USE ONLY FLASKS AND SELF-VENTING AUTOMATIC SEALING STOPPERS RECOMMENDED BY THE MANUFACTURER. THIS WILL HELP TO PREVENT SEALED FROM EXPLODING AND LIQUIDS IN GLASS CONTAINERS FROM RUPTURING
	WASTE THAT CONTAINS BLEACH MAY HARM AN AUTOCLAVE
	CAREFULLY PREPARE ITEMS FOR AUTOCLAVING. LOOSELY COVER OR CAP CONTAINERS TO AVOID OVER-PRESSURIZATION
	KEEP LOADS SMALL - OVERLOADING HINDER STEAM PENETRATION.
	BAGS SHOULD BE OPEN AND SHOULD BE CONTAINED WITHIN THE STAINLESS STEEL TRAY OR BASKET
	NEVER AUTOCLAVE NITROCELLULOSE TUBES - THEY CAN EXPLODE! DO NOT PUT FLAMMABLE, VOLATILE OR EXPLOSIVE MATERIALS INSIDE OF THE CHAMBER

### 7.3 Getting Started

- 1) Close **Drain Valve** to lock. Turn handle cross to pipeline. Drain valve is located in the right side panel.
- 2) Pour distilled water in the chamber to level of just beneath the heater protection cover is just immersed in the water.  
**\* Heater should be immersed in water at any time**
- 3) If water level is low LED displays alarm **FILL** when you press **START** button
- 4) Put prepared materials into provided basket and put basket into the autoclave chamber.
- 5) Close chamber door in right position and fasten door handle tightly to clockwise.
- 6) Close Manual Safety Pressure Release Valve in front of autoclave to clockwise tightly.
- 7) Turn circuit breaker on which located on the back panel.
- 8) Turn main power switch on located on the left side of the main controller.  
PV LED displays current temperature of the chamber.  
SV LED displays user set temperature (Factory default value is 121°C).  
Press AUTO-TUNE button to display time to autoclave and temperature alternatively.  
(Factory default value is 15.00 - 15 minutes).

## WARNING

	DO NOT OPERATE WITHOUT WATER INSIDE OF THE CHAMBER HEATER IN THE CHAMBER SHOULD BE IMMERSSED IN THE WATER TO PREVENT OVER HEATING OR MALFUNCTION
	IF THERE IS NO WATER IN THE CHAMBER DURING OPERATION THE AUTOCLAVE WILL MOMENTARILY OVERHEAT. THIS MAY CAUSE MALFUNCTION OF AUTOCLAVE

### 7.4 How to set Temperature

- Press MODE button to set the temperature.
- LED display panel on top (PV) displays '**TEMP**'
- LED display panel on bottom (SV), last digit of the LED display blink and prompt user input. **(000)**
- Press ◀ button to move to digit you want change value.
- Press ▶ button to change value from 0 to 9.
- Set three digits of temperature value you want to operate.
- Factory default temperature is 121°C

**The maximum operating temperature is not allowed over 121°C**

### 7.5 How to set Time

- Press MODE button after temperature set finished.
- LED display panel on top (PV) displays '**Time**'
- LED display panel on bottom (SV), last digit of the LED display blink and prompt user input. **(00.00** in mm:ss)
- Press ◀ button to move to digit you want change value.
- Press ▶ button to change value from 0 to 9.
- Set four digits of time you want to operate.
- You can set timer up to 59 min 59 sec maximum.  
(Factory default time value is 20:00 min.)
- Press MODE button to finish timer setting

### 7.6 Start Sterilization

- After set temperature and time, PV LED displays current temperature of the chamber and SV LED displays time or operating temperature.
- Be sure all safety procedure is finished.
- Press START button to start operation.
- TIMER LAMP blinks until the current chamber temperature reaches to the user set value. When the current chamber temperature reaches to the user set value the TIMER LAMP stops blinking and starts count down.
- Air in the chamber is releasing to Steam Outlet until the chamber temperature reach to 105°C. At this point Electronic Solenoid Valve automatically locked to increase pressure in the chamber.

**Refer ALL Parameter Setting to change the temperature to lock solenoid valve.**



- Temperature continuously increase and stabilize until to reach 121°C. When the temperature stabilized at 121°C, timer starts count down.

- The autoclave will continue to sterilization cycle until the time selected runs out. The autoclave **CANNOT** be opened **at any reason** until the chamber pressure will slowly drop along with the temperature.
- **If you want to stop sterilization, press STOP button. Autoclave automatically stop and solenoid valve is open to release pressure in the chamber.**
- **DO NOT open the chamber door until the pressure drop to 0**
- When sterilization time is run out, Electronic Solenoid Valve automatically opened to release pressure in the autoclave chamber slowly.
- When chamber temperature cool down to 95°C, SV LED displays **END** and beeps 30 seconds.
- Wait until the Pressure Gauge indicates 0 (zero)

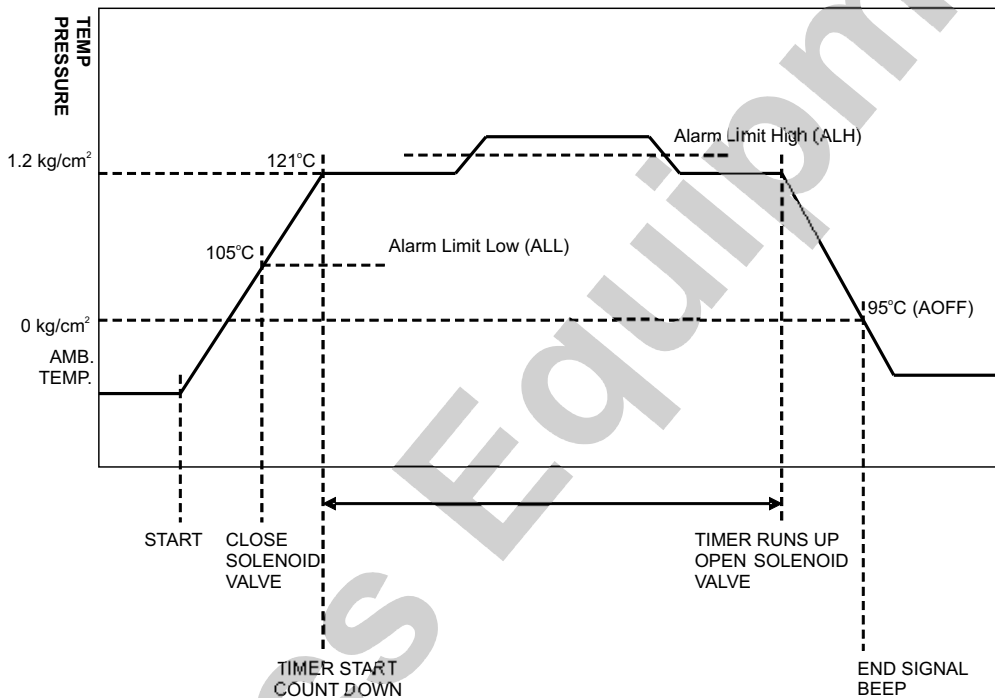
**Do not open chamber door immediately after finishing sterilization or END signal.**



### SAFETY PRECAUTION

 <b>HOT</b>	<p>DURING OPERATION, ANY PART OF THE AUTOCLAVE TOUCHING THE TOP OF THE AUTOCLAVE OR COVER MAY RESULT IN SEVERE BURNING.</p> <ul style="list-style-type: none"> <li>- cause by contact with the outside of autoclave</li> <li>- caused by contact when removing autoclaved items</li> <li>- caused by contact with pressurized steam</li> </ul>
 <b>HOT</b>	<p>KEEP AWAY FROM AUTOCLAVE AT LEAST 50 cm during OPERATION TO PREVENT BURNING CAUSED BY LEAKAGE OF STEAM.</p>
	<p>WARNING - BURN HAZARDS          CLOGGING LINES, EQUIPMENT MALFUNCTION OR FAILURE IN THE STEAM SUPPLY MAY CAUSE THE AUTOCLAVE CHAMBER TO FILL WITH SCALDING WATER. IF THE WATER LEAKS FROM ANY PART OF THE AUTOCLAVE, DO NOT OPEN THE CHAMBER DOOR. BURNS FROM SCALDING WATER MAY OTHERWISE RESULT.</p>



## 7.7 Finishing Sterilization

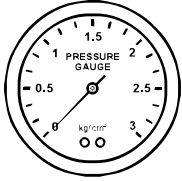

- Wear a lab coat, eye protection, heat resistant gloves and closed toe shoes.
- Once the sterilization cycle is completed, the **LED** indicates **END** signal and beep sound for 30 seconds and your autoclave finishing sterilization cycle.
- Check the Pressure Gauge indicating 0 (zero)

**Do not open chamber door immediately after finishing sterilization.**

**Be sure to wear safety goggle and heat protection gloves to avoid direct contact to prevent burning.**

- Turn the **MANUAL SAFETY PRESSURE RELEASE VALVE** on the front to counter clockwise to release pressure which may remain in the chamber for your safety.
- After completely ventilated, open the chamber door about one centimeter and allow ten minutes to let the load cool before removing tray or basket.
- Open the door and retrieve autoclaved materials.

### SAFETY PRECAUTION

 <b>HOT</b>	POTENTIAL EXPOSURE TO INFECTIOUS AGENTS THROUGH EITHER AIRBORNE, DROPLET OR CONTACT TRANSMISSION
 <b>HOT</b>	AFTER COMPLETELY VENTILATED, OPEN CHAMBER DOOR ABOUT ONE CENTIMETER AND ALLOW TEN MINUTES TO LET THE LOAD COOL BEFORE REMOVING TRAY.
	AUTOCLAVED ITEMS ARE HOT WHEN RETRIEVING FROM THE AUTOCLAVE CHAMBER. BE SURE TO WEAR PROTECTION GLOVES AND GOGGLES.

**DO NOT start another sterilization cycle before temperature drop down to 30°C. It may cause over pressure over 1.4 kgf/cm<sup>2</sup> before temperature reach to 121°C.**

## 7.8 Auto-tuning

AT (Auto-Tuning) function provides the autoclave to reach the required set temperature fast and accurately. Your autoclave was auto-tuned and tested before shipment. User do not need to auto-tune.

If parts listed below was replaced or serviced, reset all parameters and auto-tune again.

### Replacement Parts to be auto-tune again ;

1. PID Controller
2. Heater
3. PT Sensor

### Auto-Tuning Procedure ;

1. Process sterilization procedure same as described before.
2. Empty autoclave chamber
3. Set temperature at 121°C
4. Set time to 00.00
5. Press START BUTTON
6. Press and hold AUTO-TUNE button for 5 seconds
7. Auto-tuning starts with beep sound
8. AT INDICATION Lamp start blinks during auto-tuning
9. Auto-Tuning usually takes 30 minutes
10. Auto-tuning finish with beep sound and AT INDICATION LAMP STOP blinking.
11. Turn off Autoclave by pressing START/STOP button.
12. Wait until the chamber temperature drop down to below .
13. Turn the MANUAL SAFETY PRESSURE RELEASE VALVE on the front to counter clockwise to release pressure which may remain in the chamber for your safety.
14. If the pressure in the chamber completely ventilated open the chamber door and turn off the Main Power Switch.
15. Your Autoclave is auto-tuned.

## CHAPTER 8. SERVICE MANUAL

### 8.1 Draining and Refilling Water

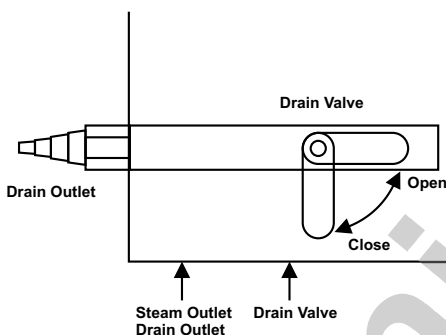

- Before draining, your autoclave should be in ambient temperature and atmosphere pressure and chamber door should be opened.
- Open the cabinet door on the right side of the autoclave
- Be sure to the drain outlet is connected to drain sink or waste basket
- Open the Drain valve to open position (parallel to the pipe line)
- Drain water in the chamber completely.
- If necessary clean the chamber
- Close the Drain valve again
- Refill the chamber with distilled water to slightly immerse heater cover on the bottom of the chamber.

**DO NOT open drain valve when pressure engaged in the chamber**

### 8.2 Spills

If there is a spill inside the autoclave chamber, allow the unit to cool before attempting to clean up the spill. If glass breaks in the autoclave, use tongs, forceps or other mechanical means to recover fragments. Do not use bare or gloved hands to pick up broken glassware.

If a spill occurs in the autoclave room, please contact your laboratory safety manager

### 8.3 Changing Water

To prevent contamination and odor, change water at least every five autoclave cycle.

## 8.4 Electric Control Panel

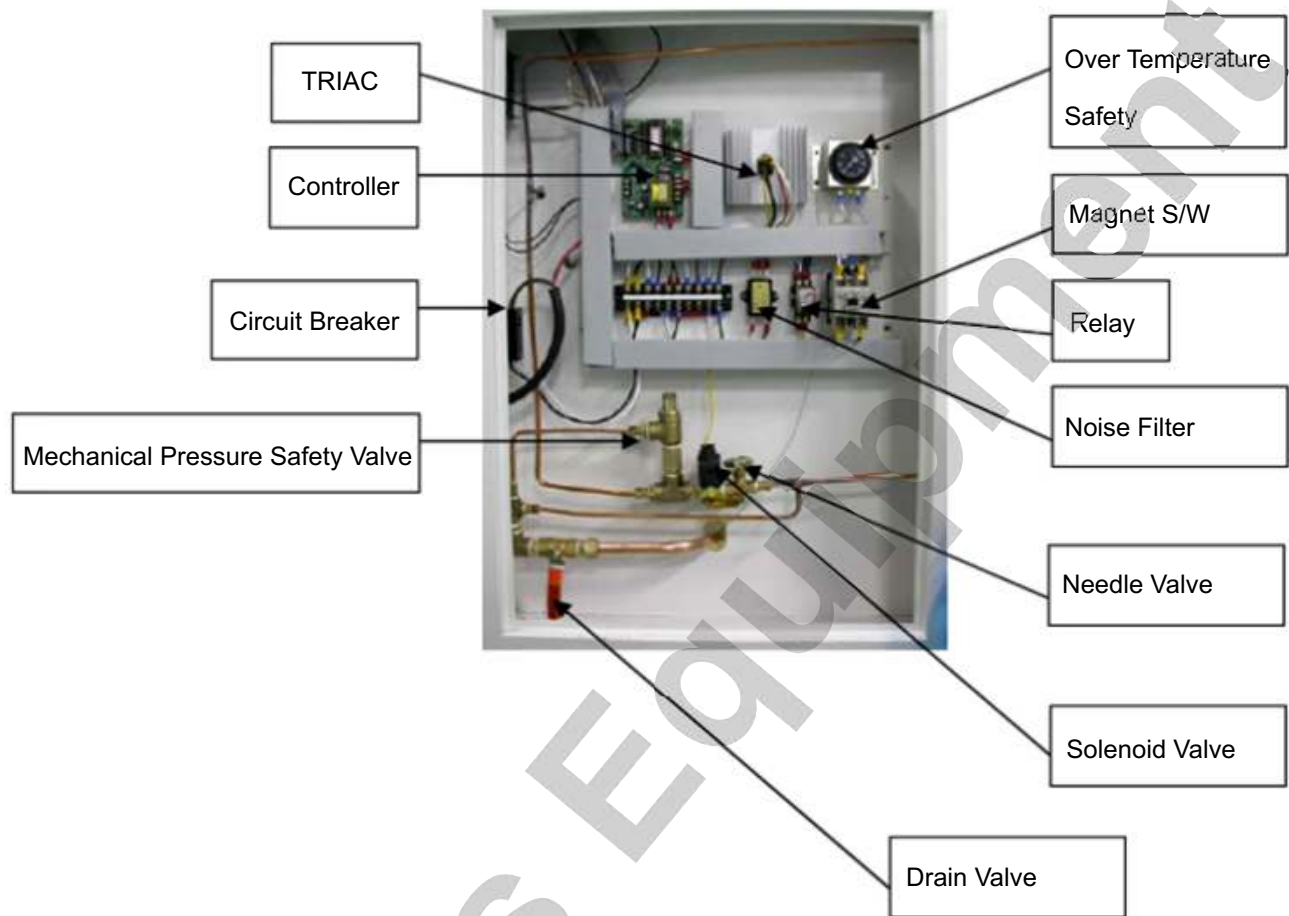

- **Over Temperature Safety** : Mechanical over temperature cut off device to protect over temperature of controller malfunction. Set at just above 123°C
- **Relay** : If relay light is on, solenoid valve is open
- **Needle Valve** : Controls pressure release time.
- **Solenoid Valve** : Automatically open and close during sterilization cycle.
- **Drain Valve** : Drain out water in the chamber
- **Mechanical Pressure Safety Valve** : Mechanically release over pressure for safety

## 8.5 Electrical Problem

Error	Display	Cause	Check	Solution
No Display	NONE	No main power connection	Check power supply cable	Plug firmly
		Power failure	Check main circuit breaker	Turn circuit breaker on
Circuit breaker trip	NONE	Low electrical power supply	Check power consumption of autoclave	Supply enough power supply
		Electric Leakage or shortage of heater	Check heater with multi-meter	Replace heater
Heating Failure	NONE	Low Over Temperature Protection Setting	Over Temperature protection in the cabinet	Set Over Temperature Protection dial higher than 140°C
		Heater disconnection	Check heater with multimeter	Replace heater
Sensor problem	NNNN uuuu	Shortage of PT Sensor	Check PT sensor integrity	Replace PT Sensor
		Open PT Sensor	Check PT sensor integrity	Replace PT Sensor
Over Temperature higher than 125°C	uuuu uuuu uuuu	Controller malfunction	Check Controller	Replace Controller
		Shortage of TRIAC	Check TRIAC	Replace TRIAC
		Shortage of circuit	Check circuit and electric components	Replace defective parts
Low Water Level	FILL	Low water level	Check water level	Fill water up to water level sensor

## 8.6 Pressure Pipe Lines

Leakage on the pressure pipe line may cause severe damage of the autoclave or safety problem.

Call authorized service engineer if you found any leakage of steam or water droplets through the pipe line.

## CHAPTER 9. SETTING PARAMETER



**Important parameters are locked before shipment for your safety.**

**This section is for service technician not for Autoclave user.**

**Do not change important parameters described below at any time.**

**Factory default values are different from product to product. Every individual Autoclaves are tested and adjusted at it's optimum parameter setting.**

**Parameter value shown below are just for reference.**

## 9.1 Parameter 1

To set parameters,

Get back to normal display mode

Press and hold MODE Button for 5 seconds.

LED displays "ALH" and waiting for user input.

Press SHIFT and INC Button to change values.

Press MODE Button to go next parameter.

To escape from Parameter mode to normal display mode, press and hold MODE Button for 6 seconds.

Parameter Symbol	Name of Parameter	Setting Range and Descriptions	Factory Default Value	User Set Value										
ALH	ALARM LIMIT HIGH (RELATIVE VALUE)	00.0 ~ 99.9	2	DO NOT CHANGE										
	Relative value of temperature of High Alarm where controller stop output to heater. Ex. If SV is 121°C and ALH is 2°C, controller stop output to heater when the PV is higher than 123°C.													
ALL	ALARM LIMIT LOW (RELATIVE VALUE)	00.0 ~ 99.9	6	DO NOT CHANGE										
	Relative value of temperature of Low Alarm where controller close Solenoid Valve during operation. Ex. If SV is 121°C and ALL is 16°C, controller close Solenoid Valve at 105°C to increase temperature and pressure.													
HYS	HYSTERESIS		0.3	DO NOT CHANGE										
	Range of Alarm point where alarm activate and inactivate.													
BEEP	BEEP ON TIME	0 ~ 9999 SEC	30	DO NOT CHANGE										
	Beep on time in seconds after timer run out. If the value is set at 0, continuously beep													
ADJ	Temperature Adjustment	-99.9 ~ 299.9	0	DO NOT CHANGE										
	Compensate temperature deviation If the actual temperature measured by standard thermometer is different from temperature which controller read, user can compensate temperature difference by Adj function Ex. Actual temp = 100.0    Displayed temp = 99.9    SetAdj at 0.1 Actual temp = 99.5    Displayed temp = 100.0    SetAdj at -0.5													
Loc	LOCK PASSWORD	0000, 1111	0010	LOCKED										
	Protect set values and parameters from unauthorized change													
	<table style="margin-left: auto; margin-right: auto;"> <tr> <td></td> <td>N3</td> <td>N2</td> <td>N1</td> <td>N0</td> </tr> <tr> <td>Available value to set</td> <td>0 or 1</td> <td>0 or 1</td> <td>0 or 1</td> <td>0 or 1</td> </tr> </table>					N3	N2	N1	N0	Available value to set	0 or 1	0 or 1	0 or 1	0 or 1
	N3	N2	N1	N0										
Available value to set	0 or 1	0 or 1	0 or 1	0 or 1										
	Where N3 : KEY LOCK                      1 : LOCK    0 : UNLOCK													
	N2 : RESERVED                              1 :            0 :													
	N1 : PARAMETER DATA LOCK    1 : LOCK    0 : UNLOCK													
	N0 : SET VALUE DATA LOCK    1 : LOCK    0 : UNLOCK													
	N3 (KEY LOCK) : Protect pressing button.													
	N1 (PARAMETER DATA LOCK) : Protect parameter values stored in the controller													
	N0 (SET VALUE DATA LOCK) : Protect user set values such as temperature and time													

## 9.2 Parameter 2

To set factory parameters,

Get back to normal display mode

Press and hold MODE Button for 30 seconds.

LED displays "RNT" and waiting for user input.

Press SHIFT and INC Button to change values.

Press MODE Button to go next parameter.

To escape from Parameter mode to normal display mode, press and hold MODE Button for 6 seconds.

Parameter Symbol	Name of Parameter	Setting Range and Descriptions	Factory Default	User Set Value
<b>RNT</b>	Maximum temperature limit to set	-99.9 ~ 299.9°C	123	DO NOT CHANGE
	Maximum temperature limit to set. If rnt value set at 125°C, user cannot input operating temperature higher than 125°C If PV temperature is higher than rnt value by any reason, controller displays uuuu and stop operation.			
<b>ACTP</b>	Temperature where timer activated	00.0 ~ 99.9°C	0	DO NOT CHANGE
	Absolute value (Current Temp. - Set Temp.) > ACTP then timer starts  <div style="display: flex; justify-content: space-around;"> <div style="text-align: center;"> <p>Temp set temp.</p> <p>timer start   timer end   time   timer start</p> <p>Where ACTP = 0</p> </div> <div style="text-align: center;"> <p>Temp (Set temp - ACTP) set temp.</p> <p>timer start   timer end   time   timer start</p> <p>Where ACTP &gt; 0</p> </div> </div>			
<b>PRO</b>	Period (Output Interval)	1 ~ 99 sec.	5	DO NOT CHANGE

<b>P</b>	Proportion	0 ~ 9999	Auto-Tune	DO NOT CHANGE																													
<b>I</b>	Integral	0 ~ 9999	Auto-Tune	DO NOT CHANGE																													
<b>D</b>	Differential	0 ~ 9999	Auto-Tune	DO NOT CHANGE																													
<b>Mode0</b>	OPERATING MODE CONTROL	0000 ~ 1111	0000	DO NOT CHANGE																													
	<table style="width: 100%; border-collapse: collapse;"> <thead> <tr> <th style="width: 25%;"></th> <th style="width: 12.5%;">N3</th> <th style="width: 12.5%;">N2</th> <th style="width: 12.5%;">N1</th> <th style="width: 12.5%;">N0</th> </tr> </thead> <tbody> <tr> <td>Available value to set</td> <td>0 or 1</td> <td>0 or 1</td> <td>0 or 1</td> <td>0 or 1</td> </tr> <tr> <td>Where N3 : TYPE OF SENSOR</td> <td>1 : DIN Pt 100 ohm</td> <td>0 : KS, JIS Pt 100 ohm</td> <td colspan="2"></td> </tr> <tr> <td>N2 : ALARM HIGH DATA TYPE</td> <td>1 : ABSOLUTE</td> <td>0 : RELATIVE</td> <td colspan="2"></td> </tr> <tr> <td>N1 : ALARM LOW DATA TYPE</td> <td>1 : ABSOLUTE</td> <td>0 : RELATIVE</td> <td colspan="2"></td> </tr> <tr> <td>N0 : DECIMAL PLACE DISPLAY</td> <td>1 : YES</td> <td>0 : NO</td> <td colspan="2"></td> </tr> </tbody> </table>					N3	N2	N1	N0	Available value to set	0 or 1	0 or 1	0 or 1	0 or 1	Where N3 : TYPE OF SENSOR	1 : DIN Pt 100 ohm	0 : KS, JIS Pt 100 ohm			N2 : ALARM HIGH DATA TYPE	1 : ABSOLUTE	0 : RELATIVE			N1 : ALARM LOW DATA TYPE	1 : ABSOLUTE	0 : RELATIVE			N0 : DECIMAL PLACE DISPLAY	1 : YES	0 : NO	
	N3	N2	N1	N0																													
Available value to set	0 or 1	0 or 1	0 or 1	0 or 1																													
Where N3 : TYPE OF SENSOR	1 : DIN Pt 100 ohm	0 : KS, JIS Pt 100 ohm																															
N2 : ALARM HIGH DATA TYPE	1 : ABSOLUTE	0 : RELATIVE																															
N1 : ALARM LOW DATA TYPE	1 : ABSOLUTE	0 : RELATIVE																															
N0 : DECIMAL PLACE DISPLAY	1 : YES	0 : NO																															

<b>Mode1</b>	OPERATING MODE CONTROL	0000 ~ 2111	2100	DO NOT CHANGE
	<p style="text-align: center;">N3    N2    N1    N0</p> <p>Available value to set 0 or 1   0 or 1   0 or 1 or 2   0 or 1</p> <p>Where N3 : TYPE OF AUTOCLAVE    1 : TYPE A    0 : TYPE B    2 : TYPE C</p> <p>N2 : TIMER FUNCTION    1 : AVAILABLE    0 : NOT AVAILABLE</p> <p>(If the value set at 0, timer setting mode is not displayed in the controller)</p> <p>N1 : TIME SCALE    2 : DD:HH (00.00 ~ 99 days 23 hours)</p> <p>1 : HH :MM (00.00 ~ 99 hours 59 min)</p> <p>0 : MM:SS (00.00 ~ 99 min 59 sec)</p> <p>N0 : POWER ON RESTORE    1 : ON    0 : OFF</p> <p>(During operation, if the electrical supply is turn out and get back again, restore the last operating condition and resume operating when POWER ON RESTORE function is ON)</p>			
<b>Mode2</b>	OPERATING MODE CONTROL	0000~1111	0000	DO NOT CHANGE
	<p style="text-align: center;">N3    N2    N1    N0</p> <p>Available value to set 0 or 1   0 or 1   0 or 1 or 2   0 or 1</p> <p>Where N3 : RESERVED</p> <p>N2 : RESERVED</p> <p>N1 : ALH RELAY</p> <p>N0 : ALARM REPLAY</p>			
<b>DRAN</b>	Fix temperature display within the drAn range		0	DO NOT CHANGE
<b>AOFF</b>	After sterilization cycle, temperature where controller alarm END signal	-99.9 ~ 299.9°C	95	DO NOT CHANGE

## CHAPTER 10. INSPECTION LOG FOR AUTOCLAVE / STERILIZER

Model # : \_\_\_\_\_ Serial # : \_\_\_\_\_ Client : \_\_\_\_\_

Date & Time : \_\_\_\_\_ Amb. Temp. : \_\_\_\_\_ Electricity : \_\_\_\_\_ VAC Hz \_\_\_\_\_

### LABNICS Pretest check list (Initial after each Checkpoint)

If Non-Applicable enter N/A

Termination of each electrical connections	No gaps in packing	
Control panel key switch tight	Equipped with proper accessories	
Surge protection termination	Esthetics ok	

**LABNICS TEST AREA, TEST LOG (NOTE) If units fails any portion of the test enter "NG" in the blank space adjacent to that check point**

Technician		
<b>Esthetics OK</b>		<b>Operation</b>
Chassis		Unusual noise at startup
Powder Coating		No excessive dummy panel vibration
Chamber		Leakage on the pipe line
Control panel key switch tight		Verify solenoid valve
<b>Assembly</b>		Verify over temp. protection
Heater		Verify over pressure protection valve
Pt Sensor		Unusual vibration during run
OPT Sensor		Unusual noise during run
Pressure Gauge		Unusual fan noise or vibration
Fans Correct Blade, No Contact		Display indication and warning functions
Chamber Door seal at pull down		Temperature Max. 123°C
<b>Circuit and Wiring</b>		Pressure Max 1.3 Kg/cm <sup>2</sup>
Corresponds to Circuit Diagram		Factory Default Setting Temperature 121°C
Termination of each electrical connections		Pressure 1.2 kg/cm <sup>2</sup>
Surge protection termination		Sterilization Time 20 Min.
Molded plug not overheated		Labeling on components correct
Electrical Insulation@500VDC less than 20M		Test Run Cycles
Hi-Pot Test @ 1000VAC, 10mA, 10 sec OK		Operation Manual Included
		Safety Mark Attached
		Equipped with proper accessories



# SERVICE REPORT

Customer's Address : _____ _____	Tel.No.:
	Fax No.:
	Weekly Off.:
Contact Person / Designation :	Dept.:

Date	Time		System Configuration	Model	Serial No.	Date :	SR. No.
	From	To				Status : OK <input type="checkbox"/>	Not OK <input type="checkbox"/>
						Installation <input type="checkbox"/>	Warranty <input type="checkbox"/>
						Demonstration <input type="checkbox"/>	
						Maintenance <input type="checkbox"/>	Contract <input type="checkbox"/>
						Repairs <input type="checkbox"/>	
						Application <input type="checkbox"/>	Billable <input type="checkbox"/>
						Calibration <input type="checkbox"/>	
						Validation <input type="checkbox"/>	Courtesy <input type="checkbox"/>

Nature of Problem : \_\_\_\_\_  
\_\_\_\_\_

Observation & Action Taken : \_\_\_\_\_  
\_\_\_\_\_  
\_\_\_\_\_  
\_\_\_\_\_  
\_\_\_\_\_  
\_\_\_\_\_  
\_\_\_\_\_  
\_\_\_\_\_  
\_\_\_\_\_  
\_\_\_\_\_  
\_\_\_\_\_  
\_\_\_\_\_  
\_\_\_\_\_

Customer's Remarks : \_\_\_\_\_  
\_\_\_\_\_  
\_\_\_\_\_  
\_\_\_\_\_  
\_\_\_\_\_

Parts Replaced : \_\_\_\_\_  
\_\_\_\_\_

Parts Recommended / Action Required : Yes <input type="checkbox"/> No <input type="checkbox"/>		Requisition Number :
Service Engineer's Name & Signature	Customer's Name, Signature, Date & Stamp	



**Labnics Equipment**  
43040 Christy St., Fremont, CA 94538 USA.  
Toll Free : (877) 620 9992  
Tel. : (925) 271 4322  
Fax : (925) 886 0400  
Email : [info@labnics.com](mailto:info@labnics.com)  
Website : [www.labnics.com](http://www.labnics.com)